

Bibel tu dakdanak

Masa Saonnari/ Masa na Ro/ Hadiah

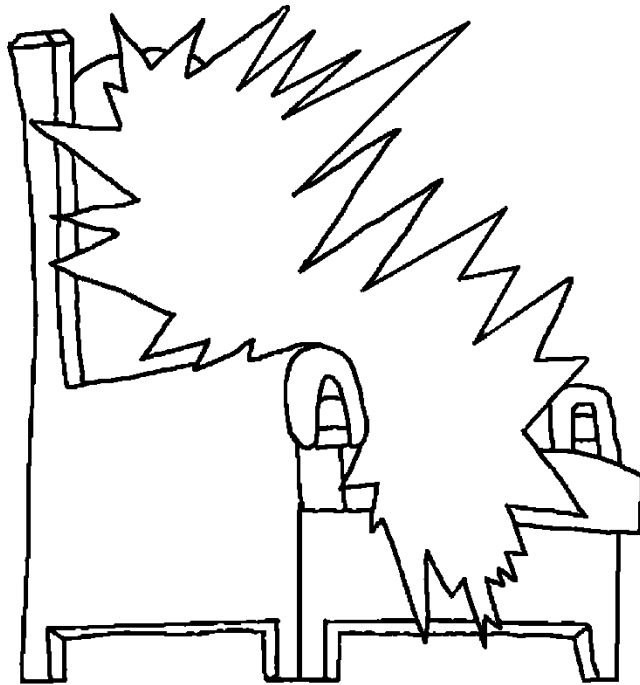

Banua Ginjang,
Bagas ni Tuhan
na Jeges i



I tulis si: Edward Hughes

Ilustrasi na I baen si: Lazarus
Alastair Paterson

Adaptasi na I baen si: Sarah S.

I terjemahan (artihon) na I baen si: christian-translation.com

I Produksi si: Bible for Children
www.M1914.org

©2021 Bible for Children, Inc.

Lisensina: Ho mampunyai hak molo naeng mancetak sanga manduplikat
carito on alai ulang I jual ho mulakan carito on.



Tikki mangolu Yesus I portibi sanga I bumi, I pabua ibana ma tu muridna songon dia banua ginjang i. Jala I dokkon ibana ma I "Bagasni Ama ni Ibana" dohot na bahatan isi gedung sanga bangunan. Gedungi baya na balgaan, Jeges museng bagas nai. Banua ginjang I baya na balgaan sanga bosaran jala mur jeges hian sian bagas I portibi on.

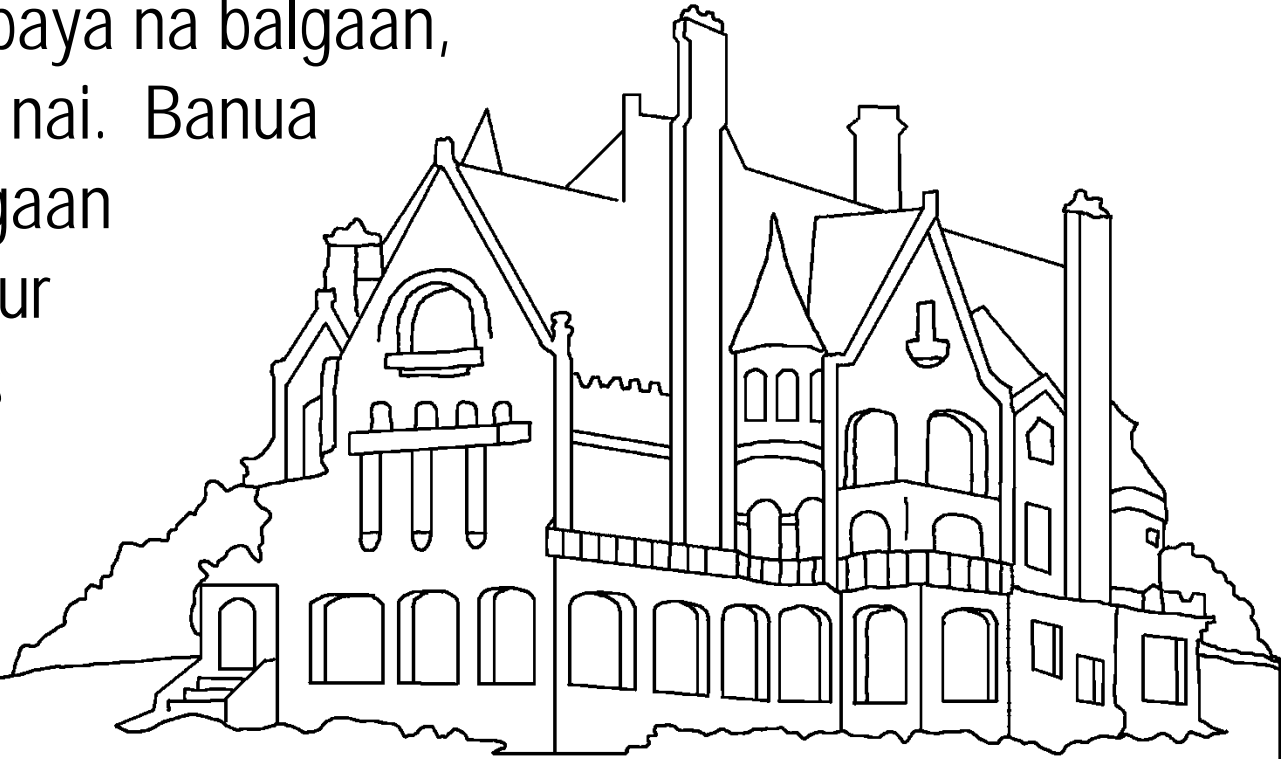

Mangecet ma Yesus I, "Giot kehe ma ahu manyiaphon tempat I ho jala anggo madung kehe au sanga madung husiaphon tempat I ho, ro ma museng au giot manyambut hamu sacara pribadi.

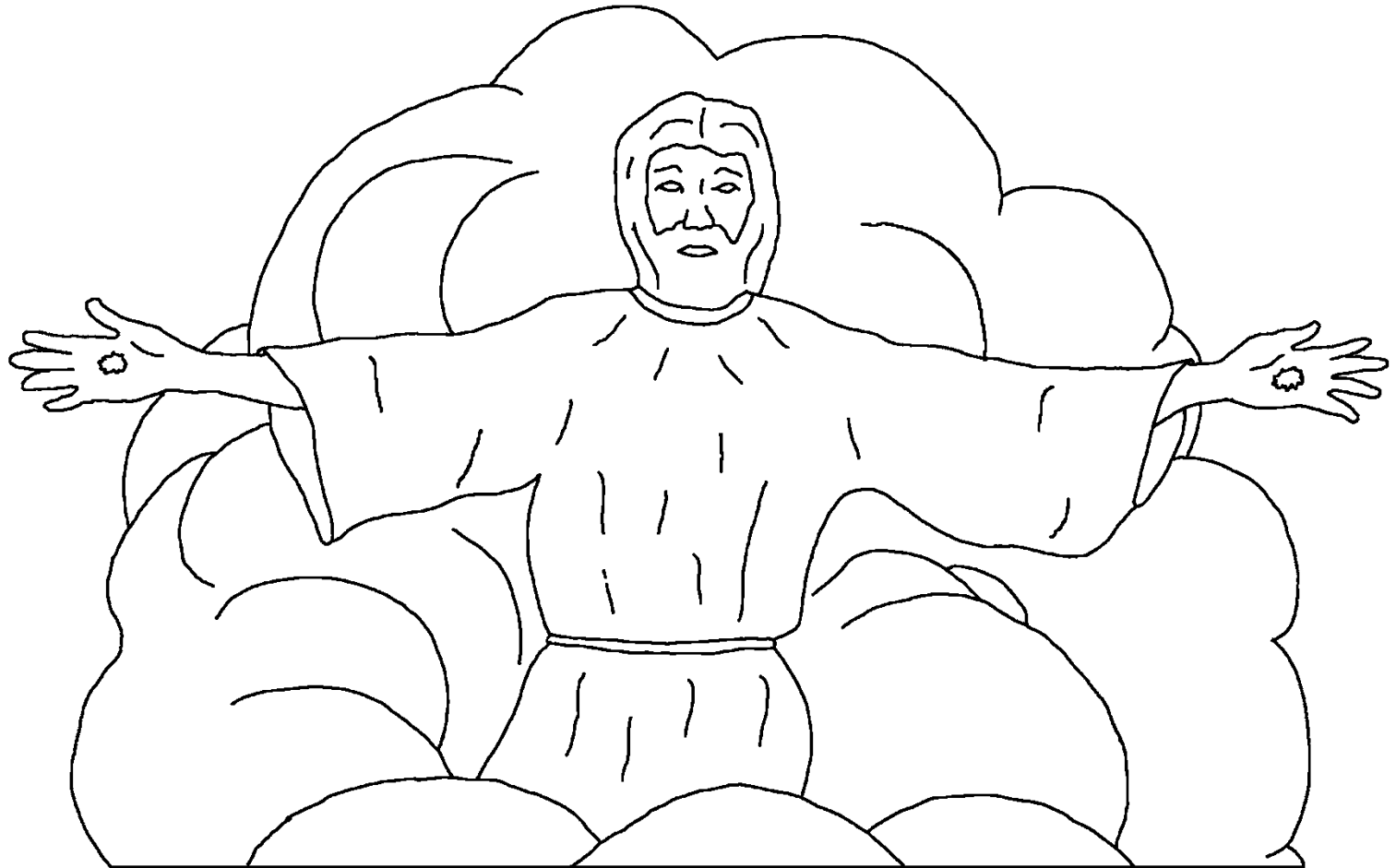

Sian I ma, Kristen on mangingot janji ni Yesus onna giot ro museng lao mangalap halaki. Pandokkon Yesus I attong toppu ro do la, nda adong namamboto sanga andigan par ro na. Alai songon dia akka halak Kristen na madung mate sangan monding I pas nda dope ro la? Bibel mandok mardalan mar iringan ma hita dojot Yesus, bope mate raga ta ala I tondi ta do pelean tu Tuhan.

Pelean tu Tuhan

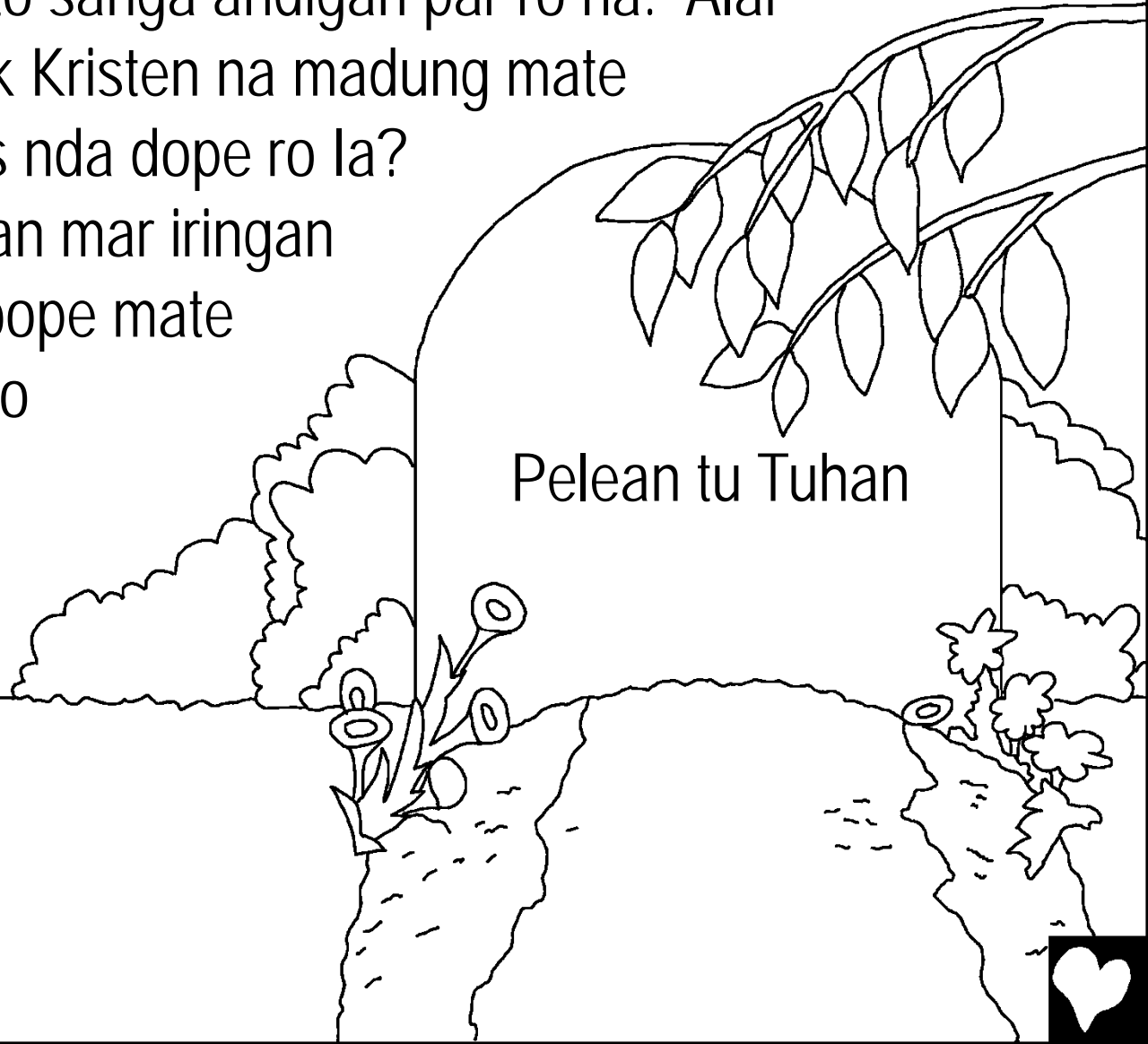

Wahyu, halumbaana sanga Patiurhon, Buku tarakhir I Bibell on mancaritohon tu hita songon dia jeges sanga denggan na banua ginjang i. Jala na paling mantap sanga special na ima bagasni Tuhan na banua ginjang i. Tuhan boi do sanga I dia sajo, alai singgasana na ni la I banua Ginjang do.

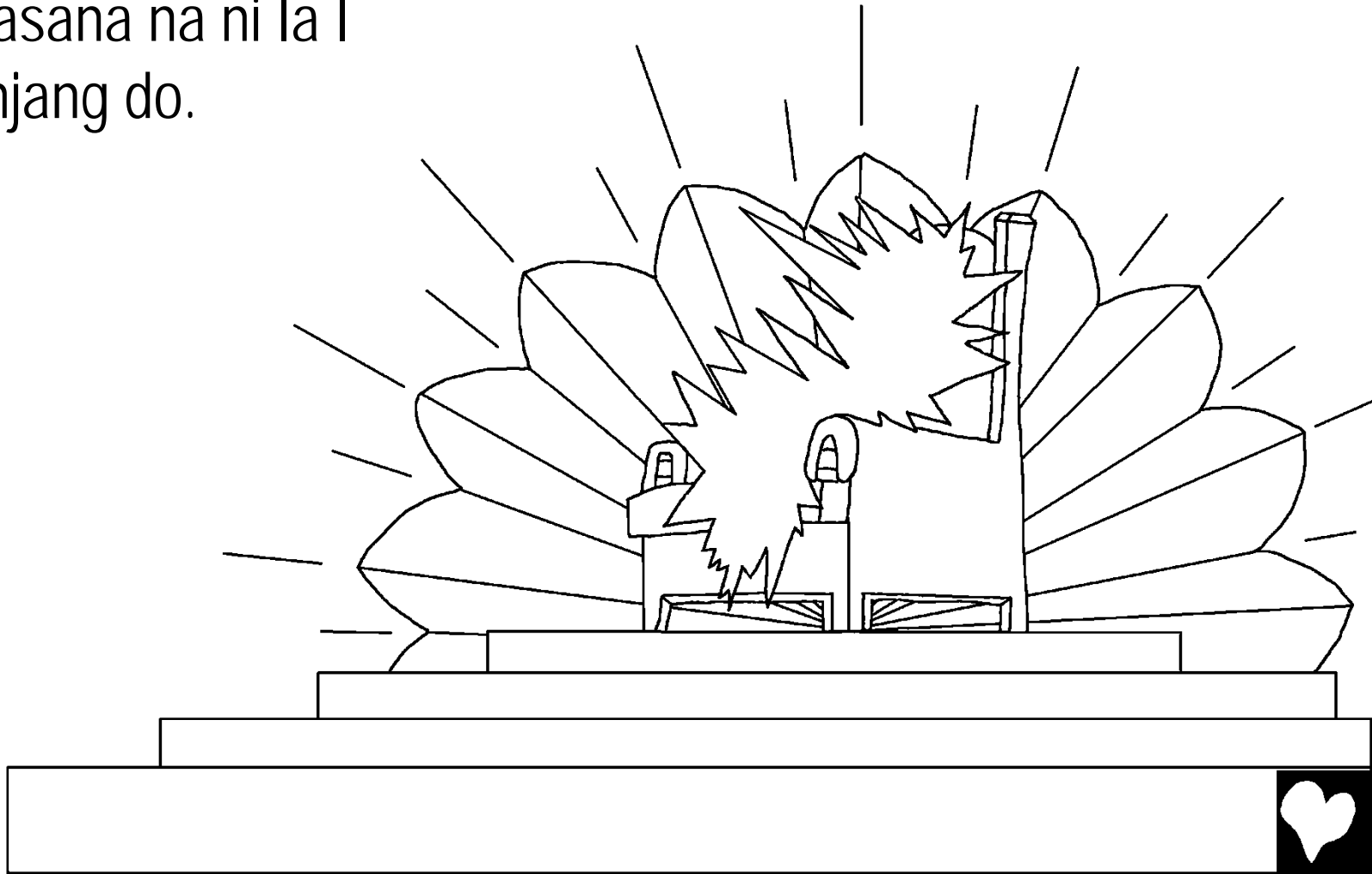

Malaikat dohot na lain manghuni
surgoi mamuja Tuhan I Banua
Ginjang. Jala alak na madung mate
sanga monding I kehe do baya I tu
Surgo. Marende i ende na special
ma halaki lao mamuja sanga
mampasonang
Tuhan.

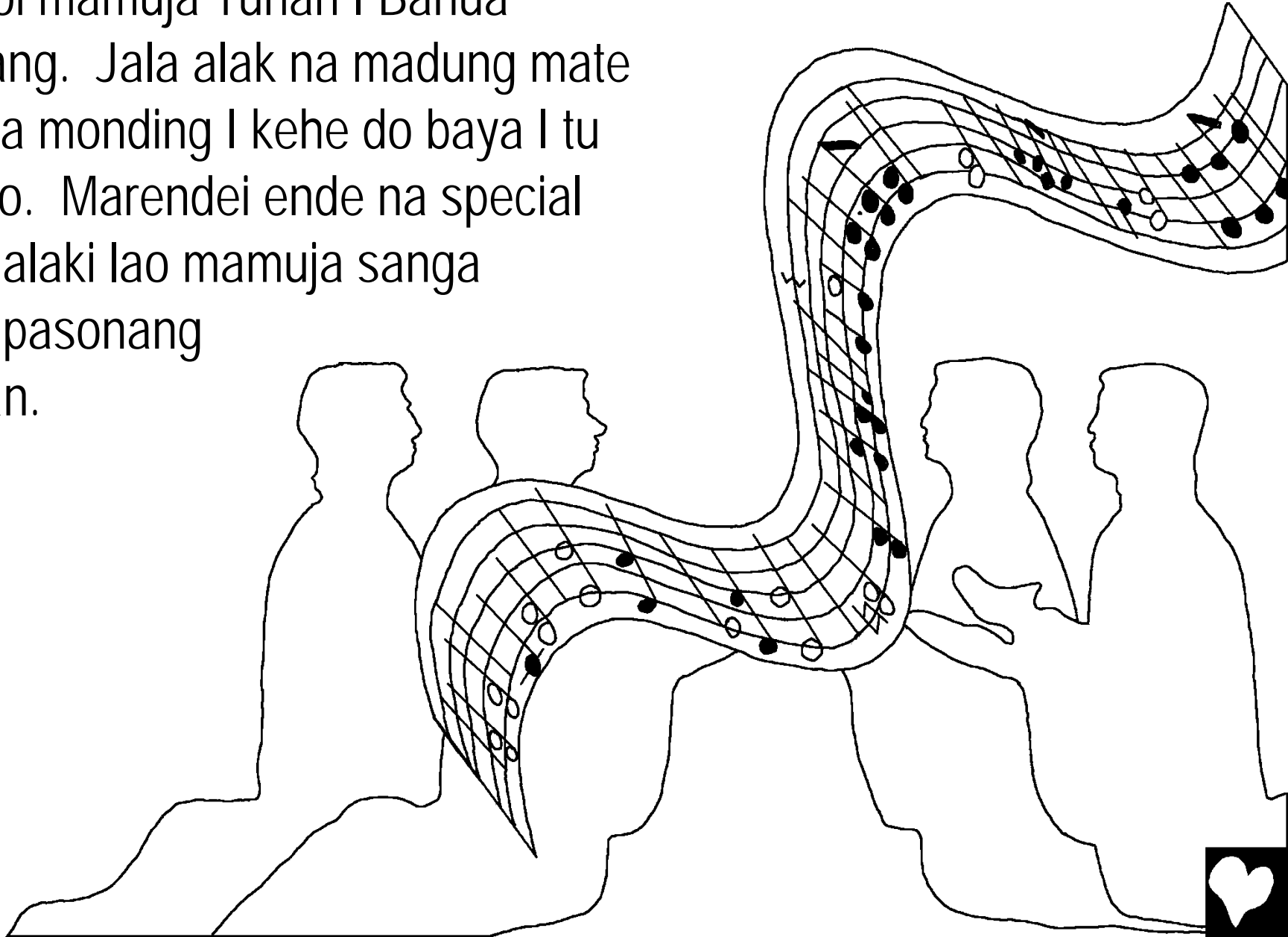

On ma baya sada hata ni sian sada ende na I endehon halaki:
"Hum Ho Sajo do na patut madunng Di tobus ho do hita sian
mudar mu tu Tuhan sian sandok Bangso
dohot Negara jala nga dibahen on Hami
manjadi Raja dohot Pandita tu Tuhan
ni Hami. (Halumbaan 5:9)

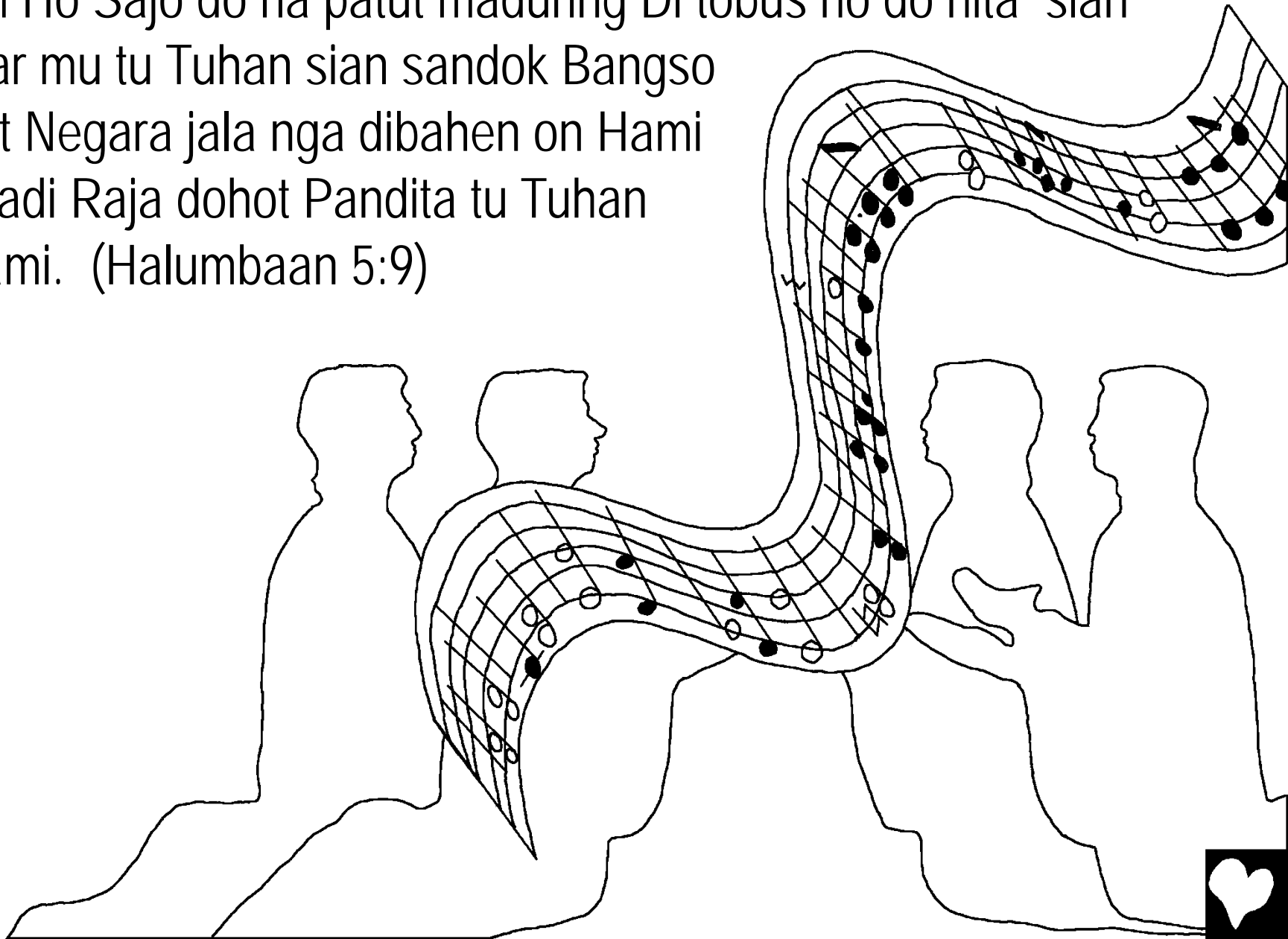

I tulisan na paling parpudi sanga akhir sian halaman ni Bibel I
jelashon do Banua Gintang I anon songon Yerusalem na Baru do i.
Na balgaan naron ni baya, balga hian, jala gintang-gintang museng
ma tembok nai, silo museng ma warna nai. Jala Pittu ni gerbang
nai baya ibaen sada-sada sian mutiara na balga hian ni do.

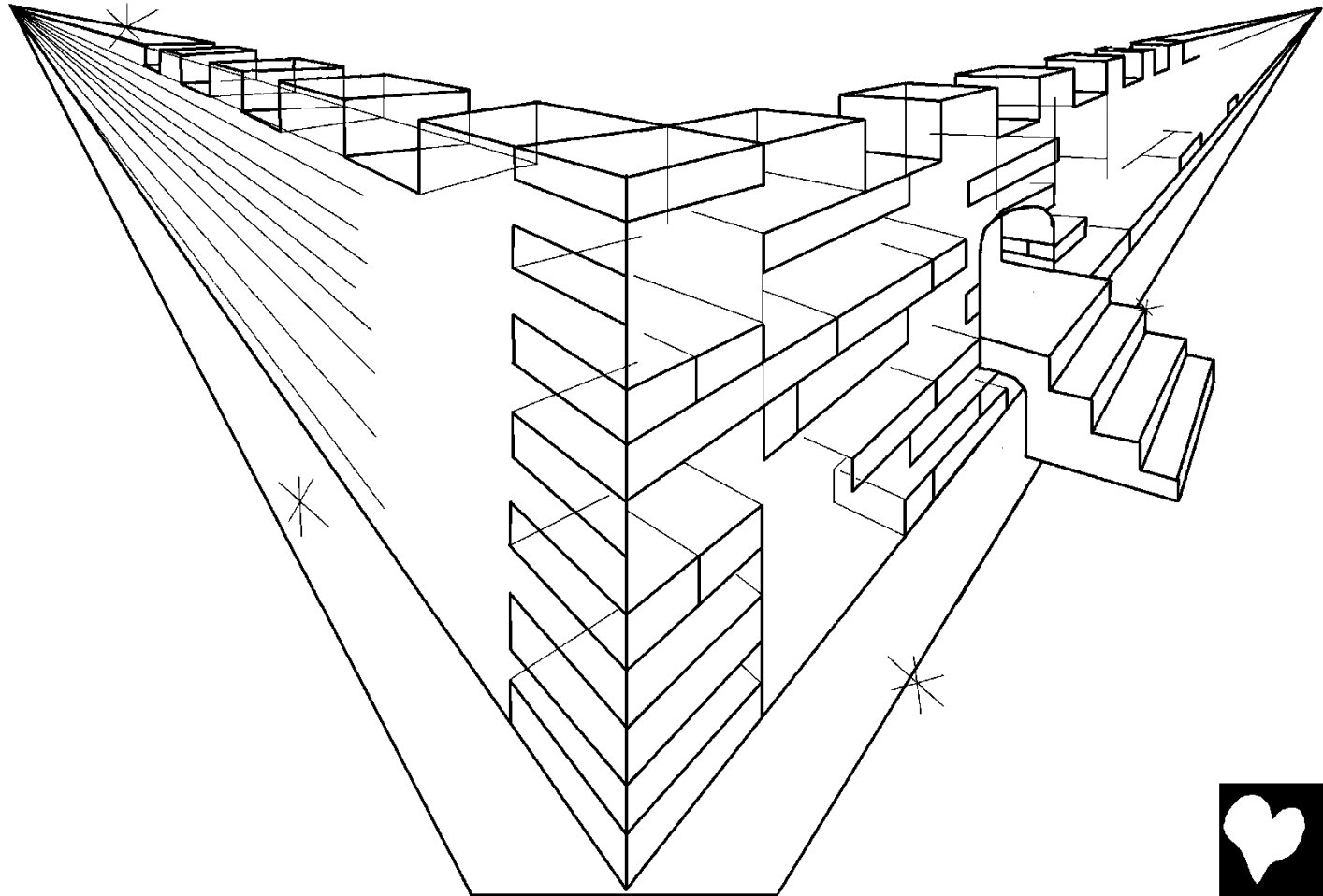

Pittu na sian mutiara I baya nda hea tutup. Ketabo tu si giot mangaligin aha na ibagasan na... WOW! Rupana surgo I lam jeges do itatap sian bagas. Kota nai baya e dibaen marlapis emas murni, molo I tatap torus songon boning kaca I ma. Jala dalam na I pe baya dibaen sian emas do.

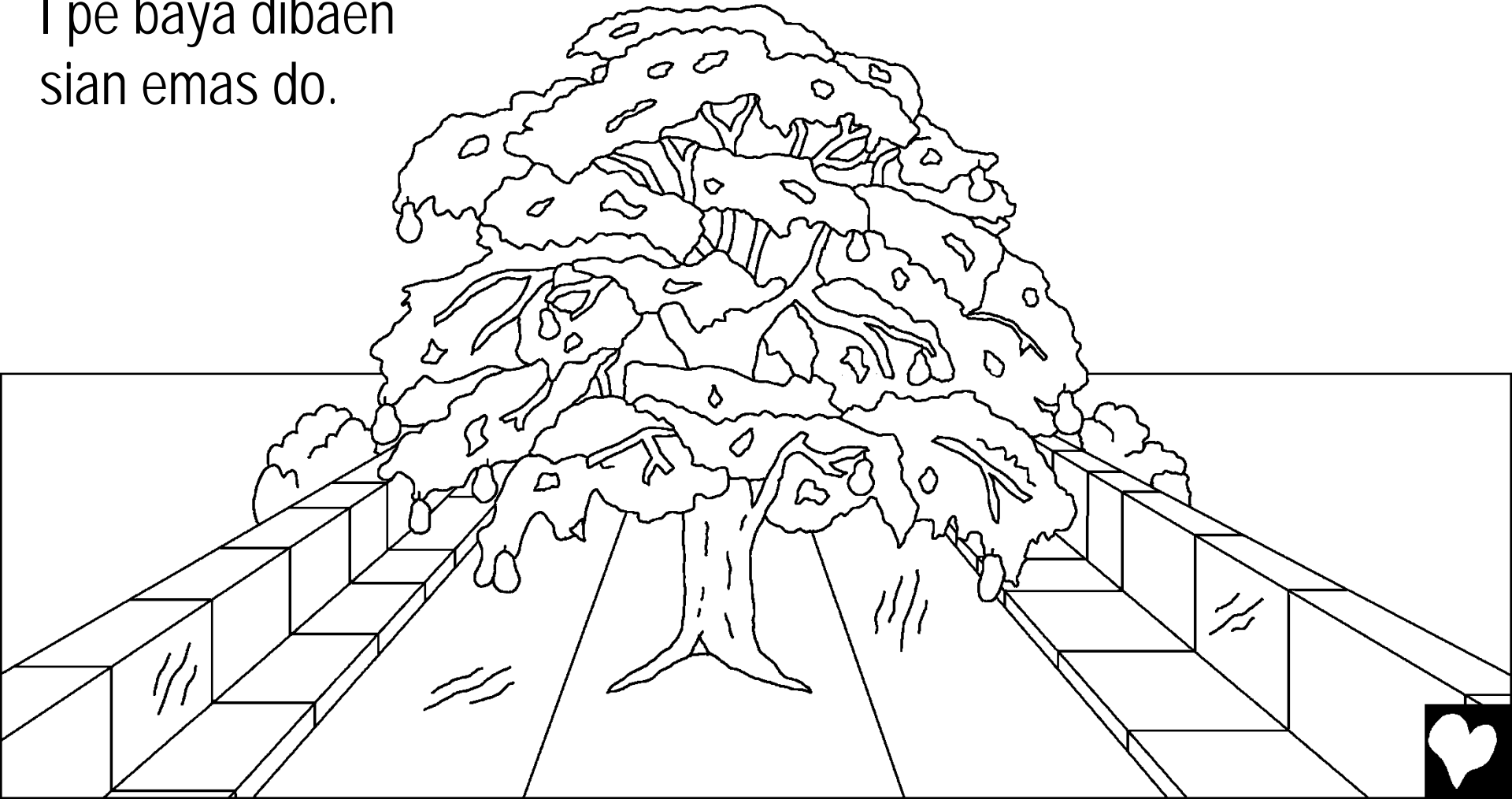

Madung Jeges, aek nai pe jorni mangalir museng aek hangouangna na marasal sian tahta ni Tuhan. Di siambirang nai aek I adong museng ma pohon hangoluan, nadia pohon on baya madung adong sian dibahen Taman Eden on. Pohon on pe baya special do, aggo marbuah pohon on adong dua bolas macam buahna, marbeda tiap bulan. Jala daun ni pohon on I ma na boi mampamalum angka bangso i.

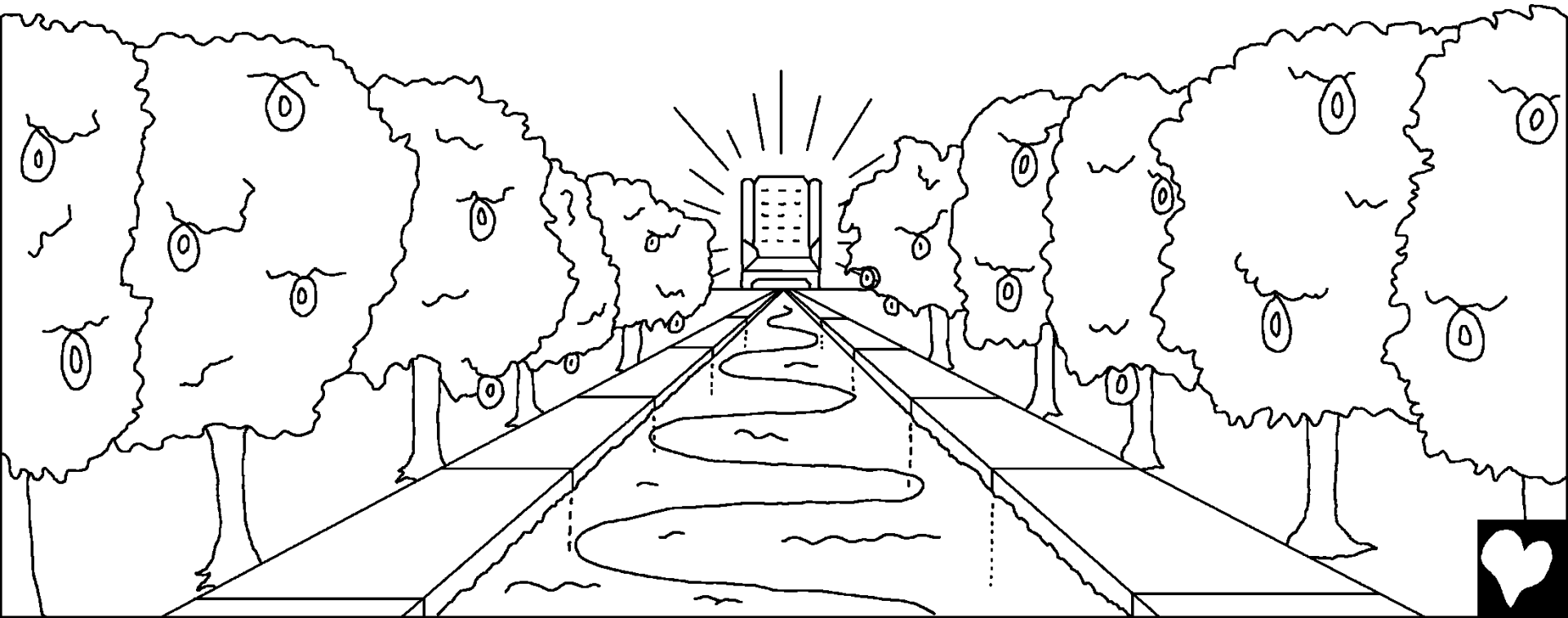

Surgo I baya e nda porlu matani ari sanga bulan giot manyinari.
Pasu-pasu ni Tuhan I madung gabe torang na denggan. Nda
adong bodari disi.

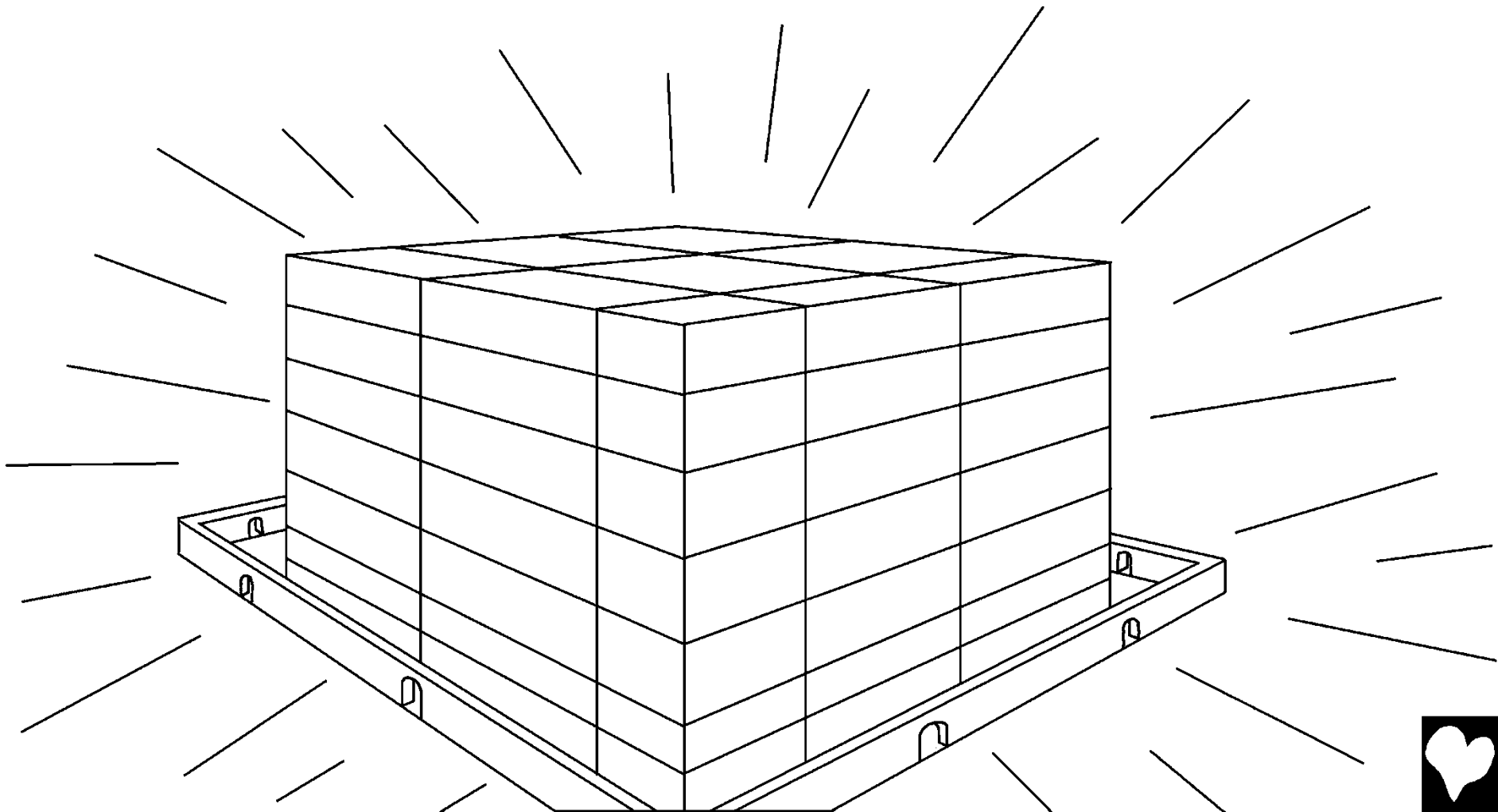

Binatang I surgo I pe marbeda sanga asing do. Madung I jinakkon do sude binatang I jala ramah do i. Serigala dohot domba rampak mamangan rumput. Singa I pe mangallan ilalang do songon sapi i. Mangepet ma Tuhan I "Nda adong halaki marbadai sanga manghancurhon sude gunung na suci i."



Molo hita bereng sakaliling,
sadar do hita adong na
hurang I bagasan surgo i.
Nda adong hata na hatcit,
nda adong na marbadai
sanga na egois, nda adong
na mangutci pittu Alana
nda adong panokko I
surgo, nda adong panipu,
pambunuh, dukun sanga
halak na jugul sanga
jahat. Nda adong akka
marmacam dosa
I surgo on.



Di Surgo on nda adong na tangis.
Alai kadang tangis do baya akka
halak na porcaya Tuhan ni giot
mangingot hasedihan saleleng
hangoluanna. Di Surgo, Di hapus
Tuhan I do baya sude akka ilu tai.



Nda adong hamatean I surgo, Halak na porcaya tu Tuhan on mangolu salelengni lelengna do dohot Tuhan nii, nda adong na marsak, nda adong na tangis, ndo adong na marsahit sanga marun, ndo adong na marsahit, nda adong na marsua sanga marsirang, nda adong na monding sanga di makamhon.



Na paling denggan sian sasudena, Di surgo akka bawa dohot ada boru sian na gelleng sahat na madung marumur porcaya tu Yesus Kristus i ma na manyelamathon halaki dohot I oloi halaki do poda sanaga dalihan ni Tuhan Ni. Soalna madung di anggap halaki la, Tuhan ni Halaki. Di Surgo I adong bukku na di dokkon Buku ni Hangoluan ni Domba.

Di Bukku on bahat do goar ni halak. Adong do goarmu tartulis di bukku i? Sude halak na porcaya Yesus tartulis di Bukku i.

Adong do goarmu tartulis disi?

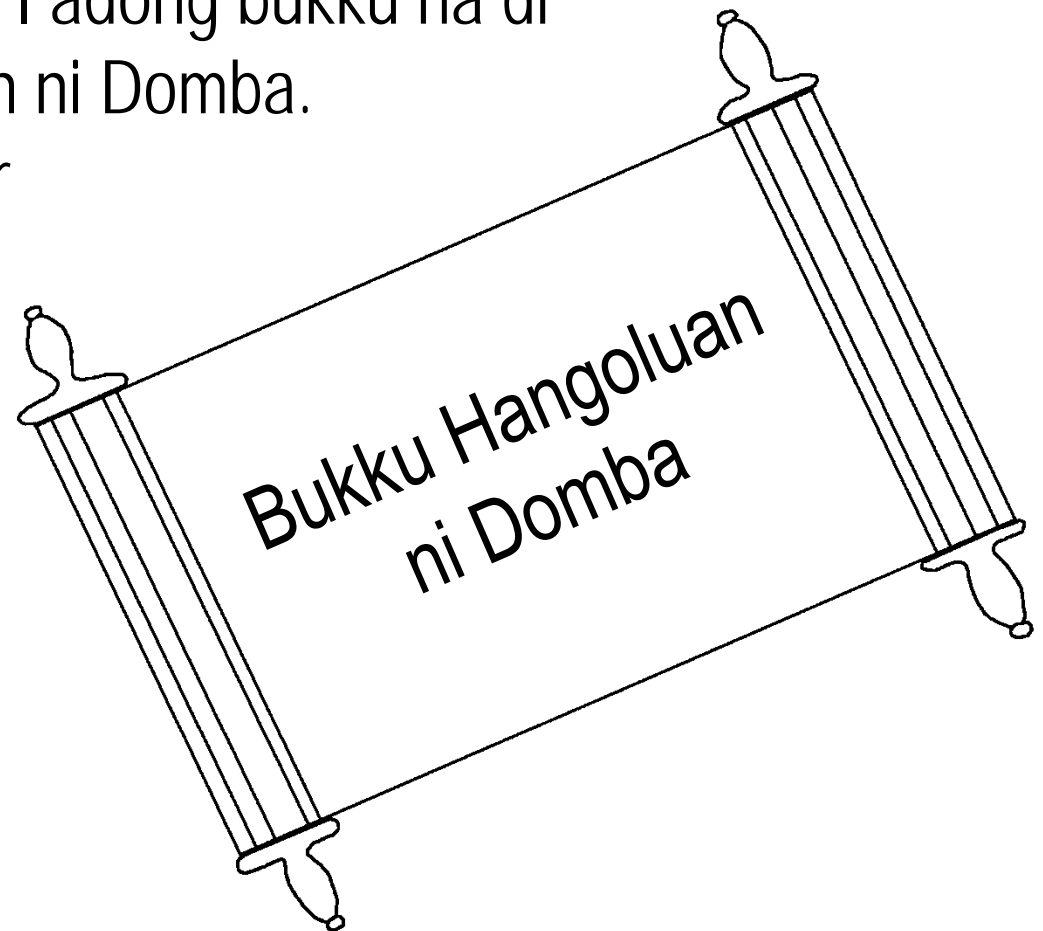

Hata tarakhir sia Bibel on tentang songon dia na I Surgo lao mangundang halak. "Jala akka tondi dohot puji-pujian ni mandokkon 'Ro ma Ho!' jala paloas ma I bege halaki halak mandok 'Ro maho!' dohot padia ma halak na mauas I ro. Jala ise na pantas mandaathon, padiar ma la ma minum Aek hangoluan ni pere-pere."

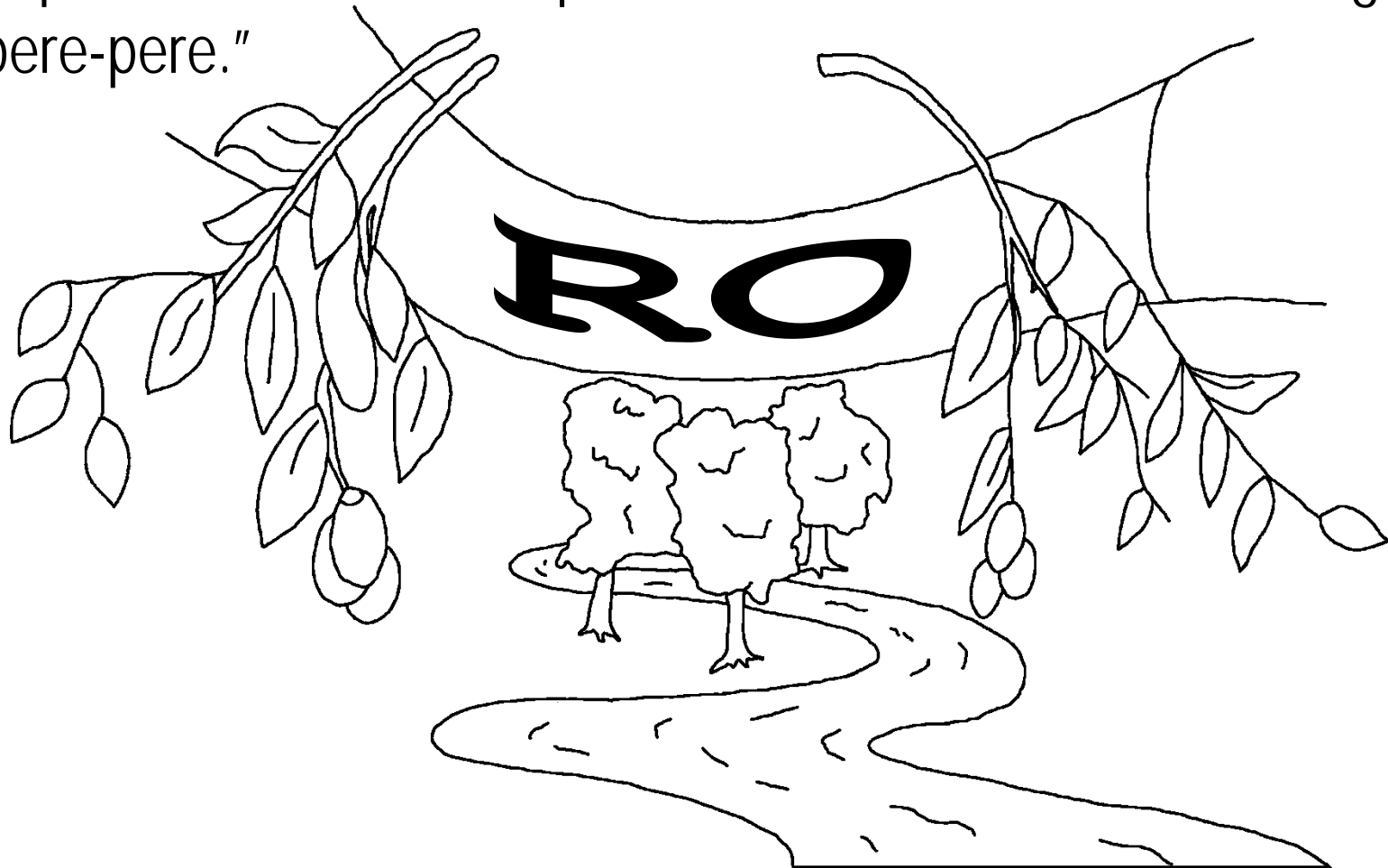

Banua Ginjang, Bagas ni Tuhan na Jeges i

Carito on dabo sian hata-hata ni Tuhan do, I ma na hita
tanda sebagai Bibel

Na mambaen sanga manamuhon na I ma

Yohannes 14; 2 Korintus 5;
Halumbaan 4, 21, 22

"Dalam masukna I ma sian hata-hata muna na mamberi
hatorangan." Psalmen 119:130



Madung Sidung
Carito Na

60

60



Bibel on baya e mancaritahon sadia hebatna Tuhan i,
na manciptahon hita dohot Tuhan na giot ho dabo mamboto Ia.

I boto Tuhan ni do baya hita na bahatan hita mambaen na jojak-jojaki, I ma na imaksudna Dosa. Hukuman ni dosa i baya hamateon do dabo, alai i sayangi Tuhani tu ho dabo alaima i kirim Ia anakna na sasada i, bope mate i salib aso manghapus hukuman ta tu dosa i. Madung mangolu ma muse Jesus i dohot mulak ia tu bagasna ima tu Surgo! Anggo Porcaya ho tu Jesus, sapai ma ibana lao mangido maaf tu dosamu. I kabulhon Ia do baya i! Ro pe ia dohot rap mangolu dohot ho, jala mangolu ma ho dohot Ia salelengni-lelengna.

Molo Porcaya (Porsaya) ho tu habonaran, dokkon ma on tu Tuhan:
Ale Jesus, Porcaya do au bahwa ho Tuhan, dohot manusia na mate tu sude sagala dosaku jala ho baya na mangolu muse. Ro ma jolo Ho tu ngolungku dohot hapusson ma sude sagala dosaku, aso boi au mempunyai kehidupan na baru, huhut i hari na ro boi au mangolu dohot Ho salelengni-lelengna. Tolong ma au asa boi mamatuhi parintahmu dohot boi mangolu dohot Ho sebaga Anak mu. Amen

Jaha ma Bibel dohot mangecet (manyapai) ma tu Tuhan saganup ari!

Johannes 3:16

