

Bible chwrai rok ni bagwi

Buma bupha

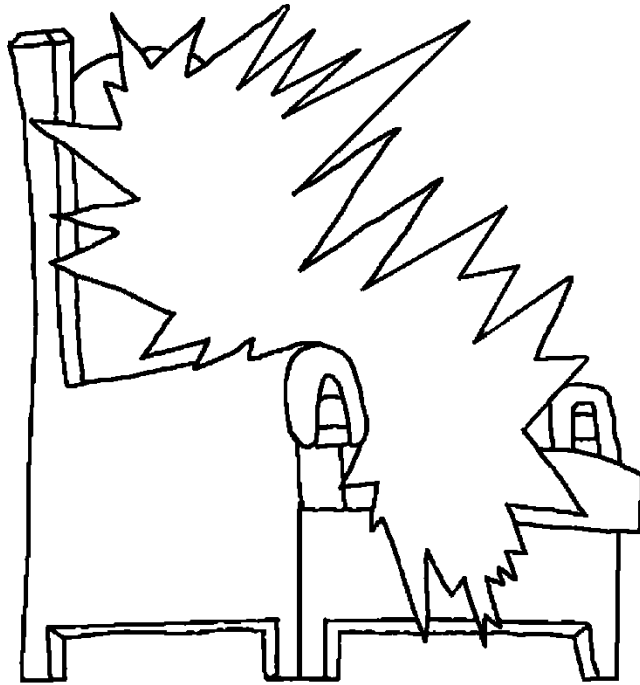

Chukha,
Kitor ni
naitbok
tongthai



Swi nai: Edward Hughes
Rwngthoma rwnai: Lazarus; Alastair P.
Yachak nai: Sarah S.
Kok slai nai:
Tikh lai nai eba kai ring nai: Bible for Children
www.M1914.org

BFC
PO Box 3
Winnipeg, MB R3C 2G1
Canada

©2021 Bible for Children, Inc.
License: You have the right to copy or print this story,
as long as you do not sell it.



Jisu o hayungo tong lang phru-o Boni sagri rk no
chukha ni kok no sawi khna rw kha. Bo abono "Ani
Apha ni nok" hwnwi salang kha, tei aro-o tong thai
kwbang ma tongo hwnwi salang
kha. A tong thai khe
kotor, naithok tong
thai. Chukha khe o
swngchar ni tong
thai ni slai tei bo
kotor tei naithok.



Jisu salang kha, "Ang norok ni bagwi tong thai snam sok na thango. Tei Ang thang baiwi norok ni bagwi tongthai snam anw, ulo ang kiphilwi phaiwi norok no ani aro tlang pahi anw, hake ang tong thanio norok bo tongwi mana nw."

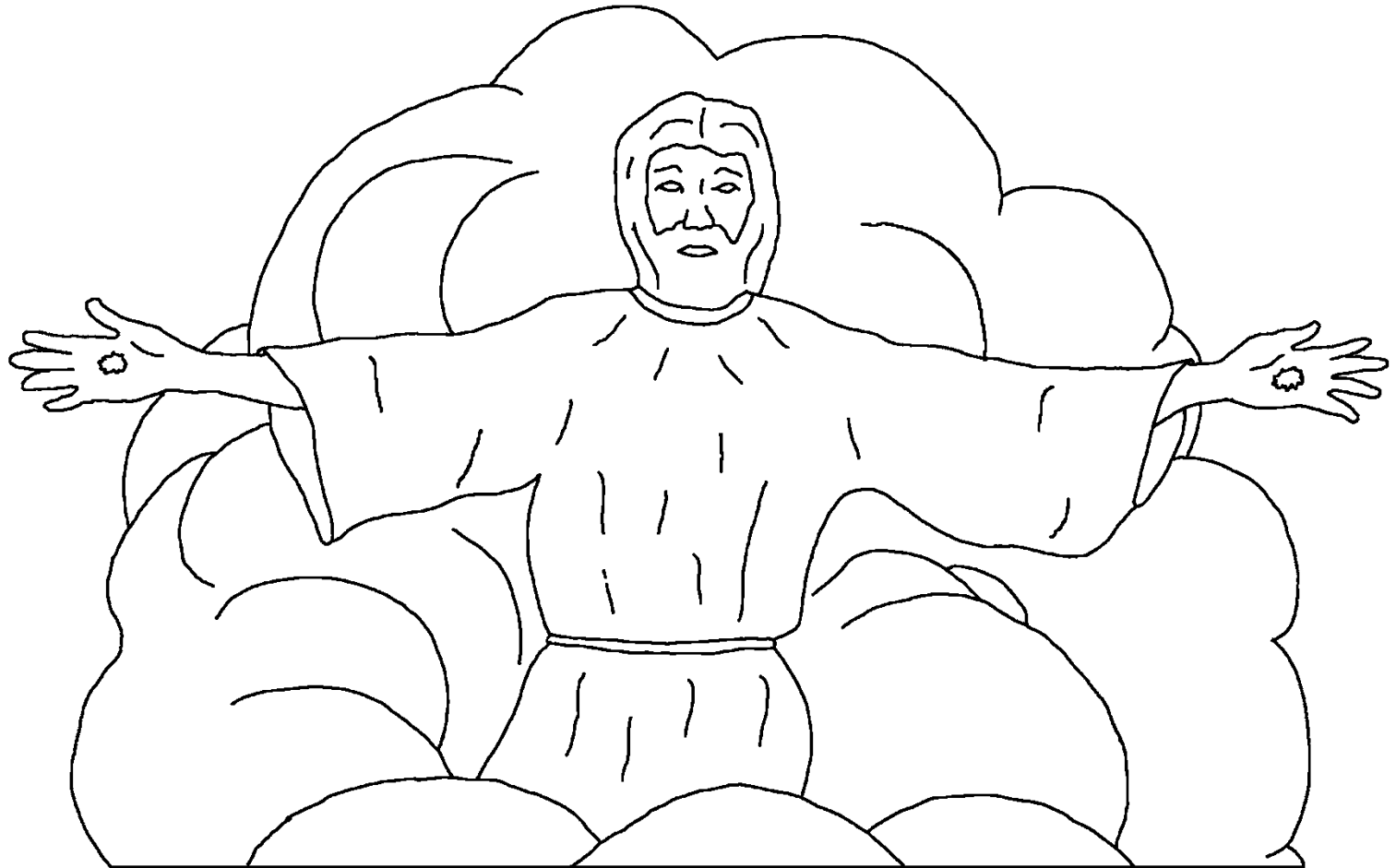

Kuthwi ni thangwi bwcha baiwi, Jisu chukha-o
thang kha. Boni sagri rok naisa wi tong phruo,
Jisu kuchugo tisawi tlang jak kha, hake chumui duls
bono kobolwi bohrok ni mokol ni hakchalo tlang kha.

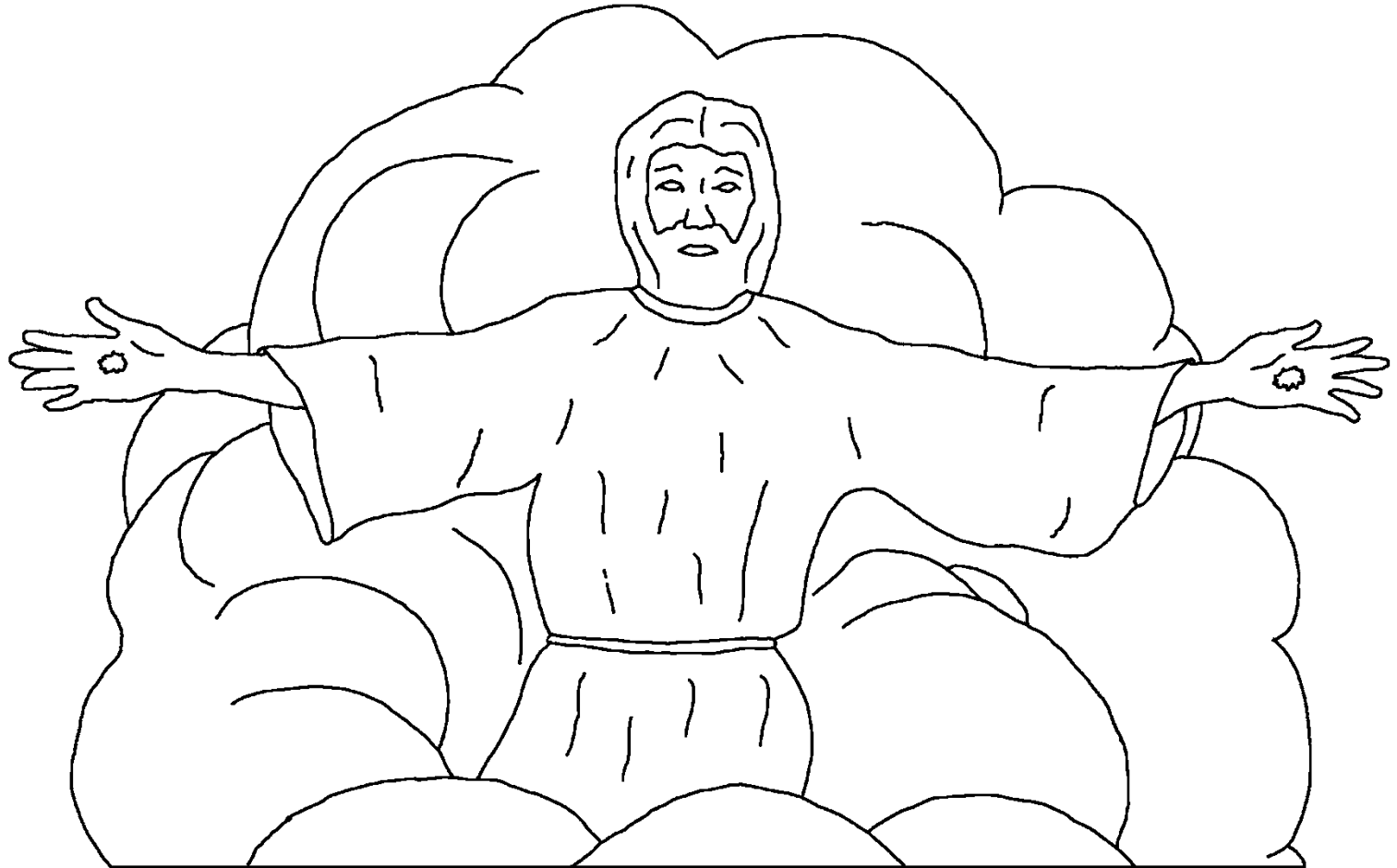

Aphuru ni chimi, Christian rok Jisu tei sa phaiwi naphai na hwnwi kok rwma no muido man la yo.

Kwbang kha kaya phuru-o, Bo achomsa kiphilwi phai nai hwnwi Jisu salang kha. Phiya Bo kiphilwi phai ya sani thwi nai Christian rok ni khe tamo wng nai? Elembak sao Jisu bai baksa tongwi na bagwi bohrok kepleng thango. Bwsago kurwi wng ma khe Bugra bai



**BUGRA BAI
BAKSA**

baksa tong na bagwi se.



Phunukjakmani, Elembakni paithak bwchap,
chuno sa-o chuknoha boswk naithothok. Jotto ni
slai wanma singcha khe, chuknoha Kaitor ni tong
thai. Kaitor joto jaga-o tongo, phiya Boni achukthai
khe chuknoha-o.

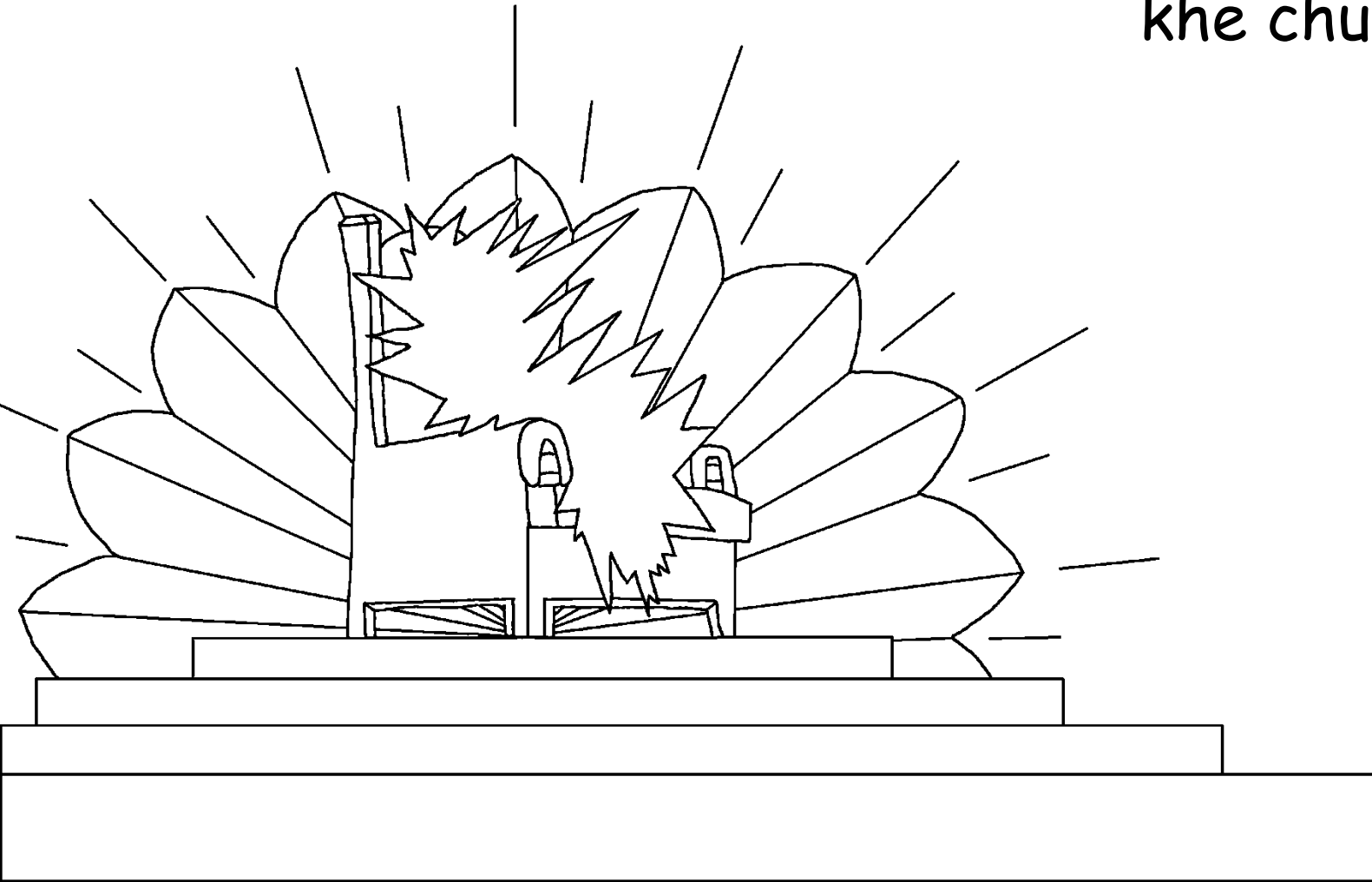

Suarirok tei bebak snamjak rok
chuknoha-o Kaitor no khlum
laiwo. Thwiwi chukha-o thang
jak Kaitor ni bororok bo abotwi
khali laiwo. Bohrok Kaitor no
lobmwng no mahmlai (special)
khe rwchap
laiwo.

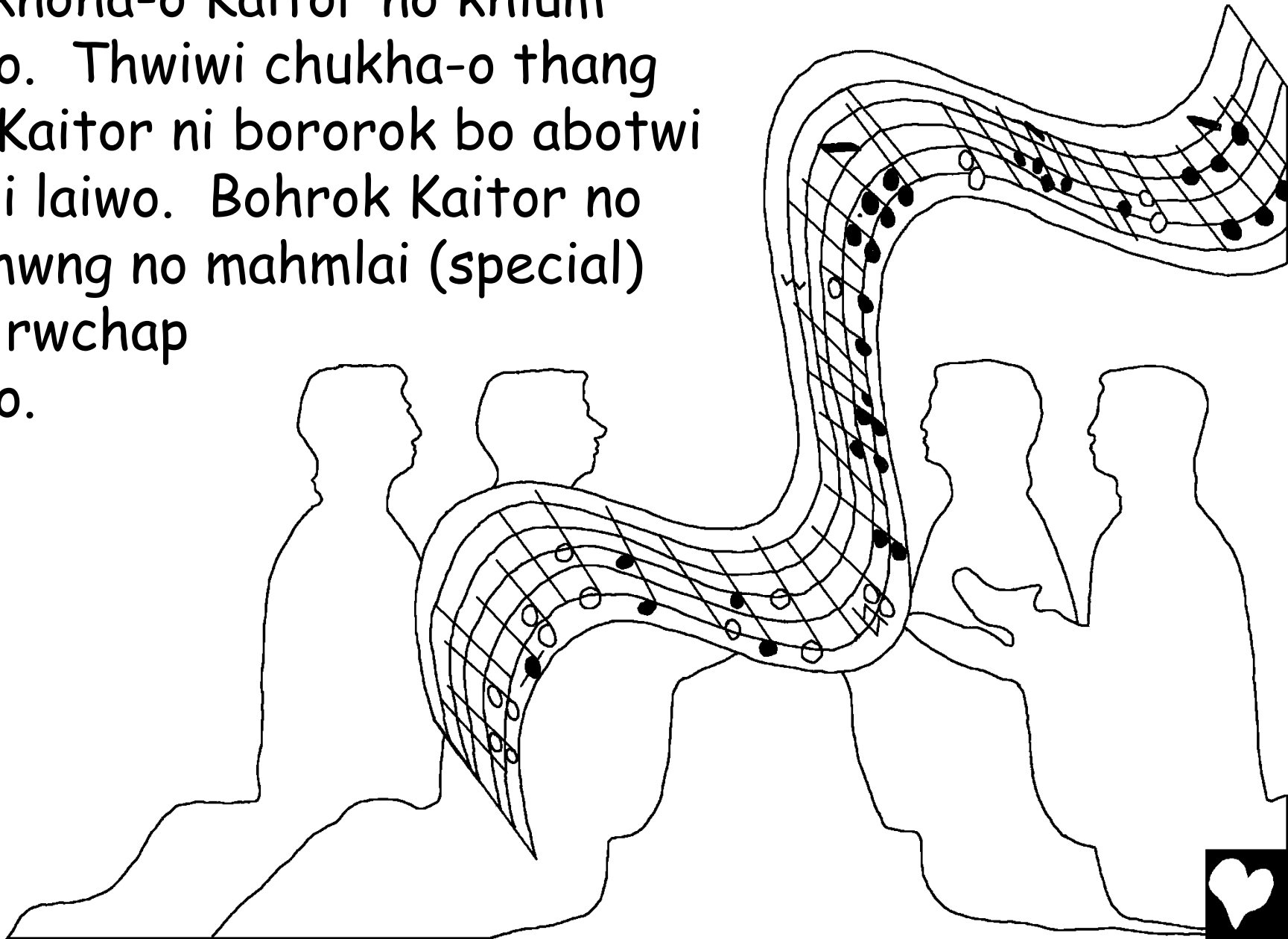

Orowo bohrok rwchap lai mani bere kisicha kokthai
rok: NWNG SE CHUKNAI TAMO KHE JOTO
BOSOSNG NI TEI JOTO HANI
BISING NI CHUNO KAITOR
NI BAGWI NINI THWI BAI
PAI KHA TEI CHUNO KAITOR
NI THANI BUGRA TEI OCHAI
SNAM KHA.

(Phunukjakmani
5:9)



Elembak ni jotto ni slai paithak ni bwchap chuknoha
no "Jerusalem kwtal" hwnwi ssao. Abo phatar twi
dewal kuchuk bai khobjak belai, belai kotor. A
dewal jasper holong bai snam jak, aina hai kwchwng.
Dewal ni yaphang rangchak tei holing morok rok bai

khobjak, jilik

jalak
bumul
bai khe
pisromjak.
Town kaisa
kaisa ni
dugalam mukta
ni holong kotor
bai snamjak!

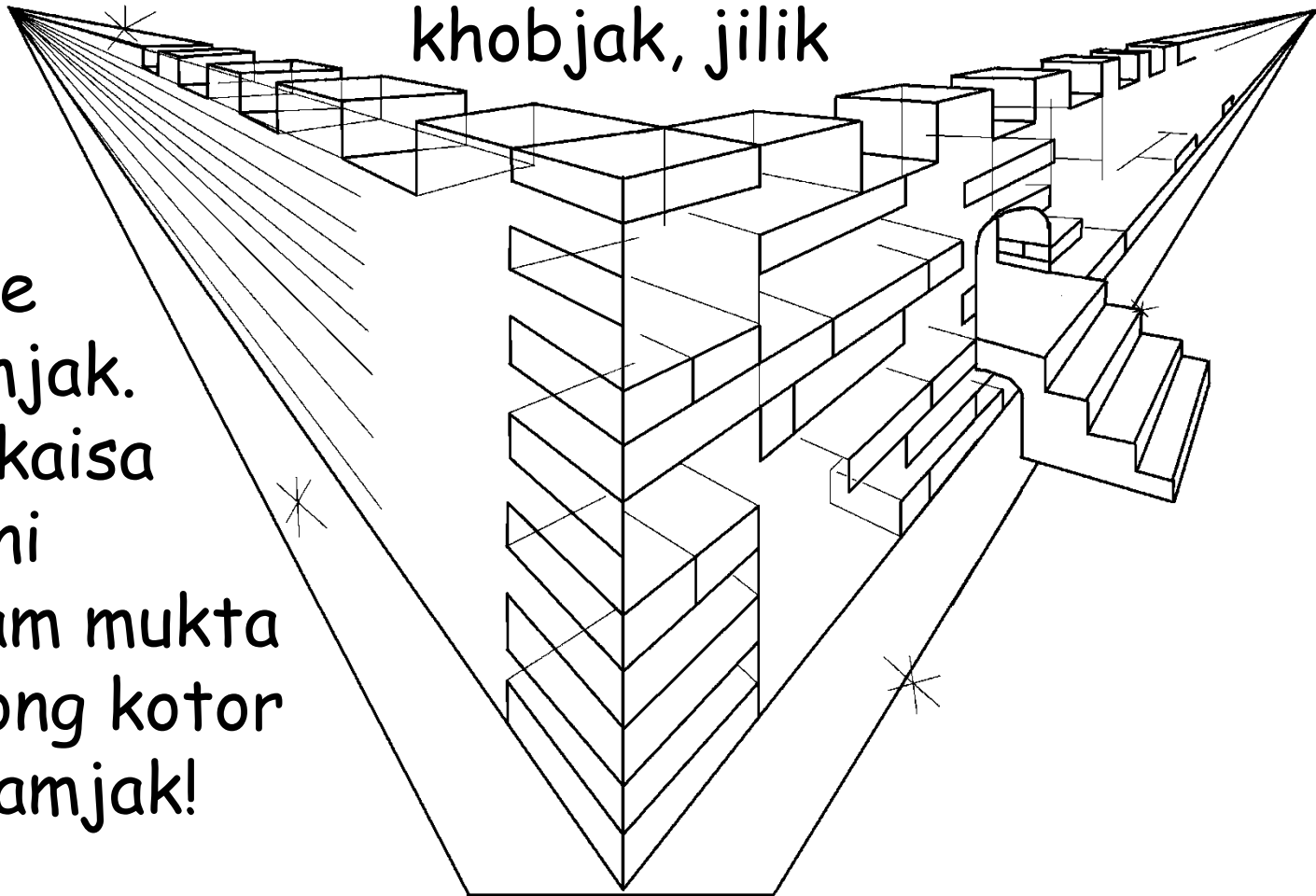

A mukta ni duglam rok waisa phano kholop jak ya.
Tho bising habwi nai lai anw ... WOW! Chkha khe
bisingo se tei bo naithok kuk. A town khe rangchak
kaham bai se snamjak, aina kuchwng hai. A lama
suda rangchak
bai snam jak.

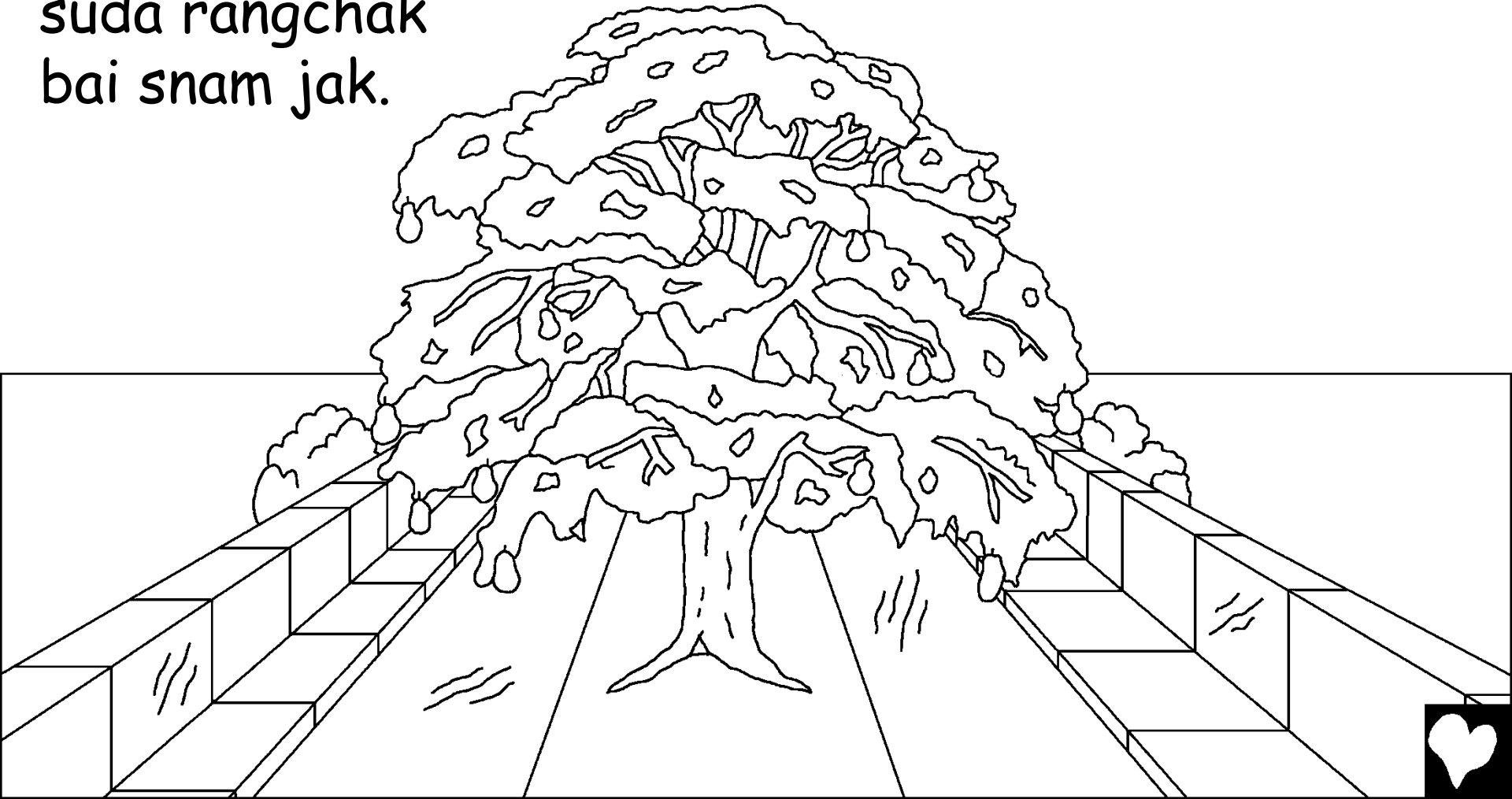

Kaisa naithok, kuchwng twi ni langma ni twima Kaitor ni achuk thai ni yorkhlai jak. A twimani babik nwnwi no Eden thai blwngo tong mani a langma ni yaphang gnang. A buphang belai khe mahmlai (special) kuk. Abo alga alga 12 dal ni bwthai tahiwo, tal brum dal sa. Tei a langmani buphang ni bwlai rok khe ha dopharok no hamrna bagwi.

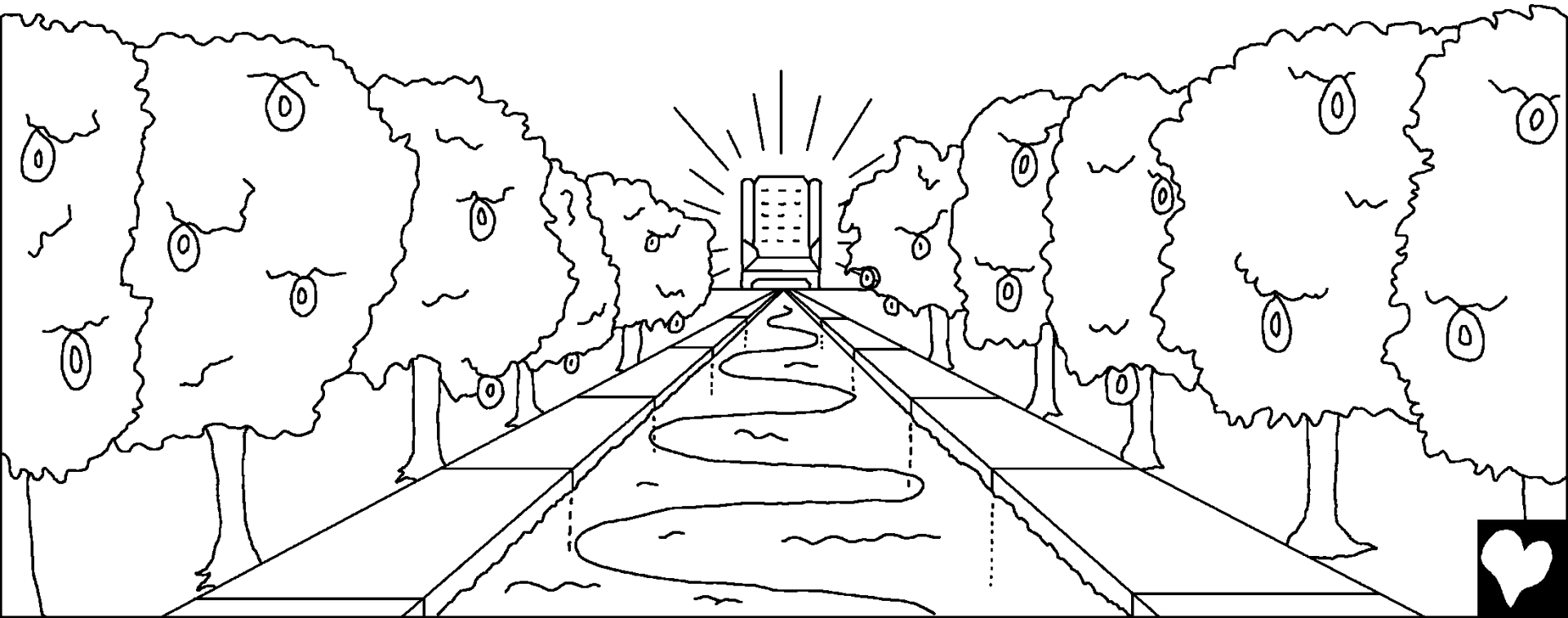

Chukha-o sal eba tal ni pohor no nang ya. Kaitor ni wanama singcha naithok pohor aoro wo pir rwi tono. Aro wo tei hor wng ya.

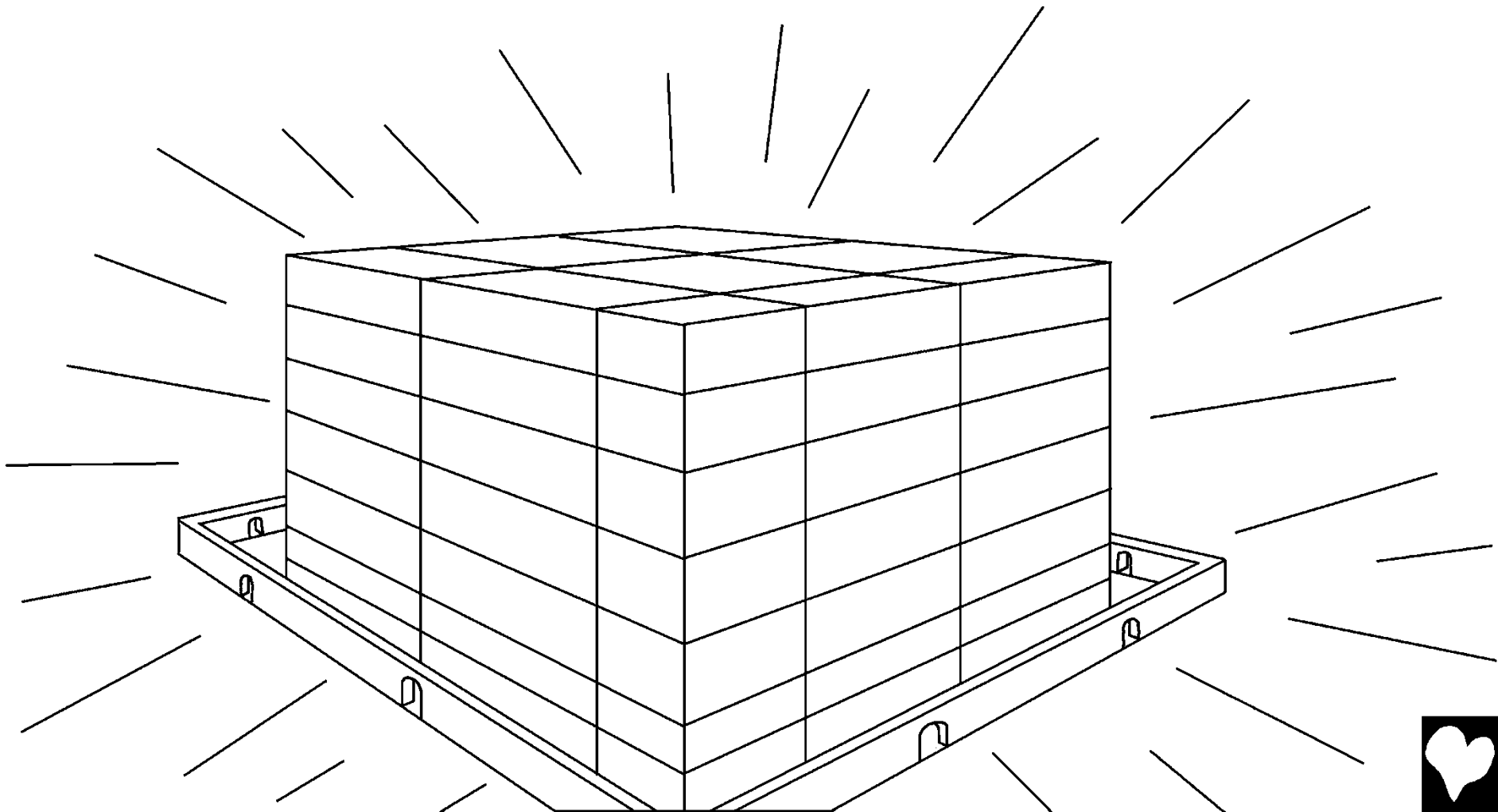

Chuknohao mal-matarok suda oroni bai pherlai jak.
Abhrok bebak kwtha lai jak. Mwsasampari rok tei
merarok baksa khe sam (Jabra) no chalaiwo. Duga
lamrogo tala rwjakya, tamo khe chuknohao sikokrok
kwrwi. Aro tatal sanairok, borok bwthar nai, swkal
khlai nai rok, tei kumun borok hamya rok bo kwrwi.
Chuknohao kunu kisim ni sumsok kuurwi.



As we look around,
we notice that
there are things
missing from
Heaven. No
angry words
are ever
heard.
Nobody
is fighting
or being
selfish.

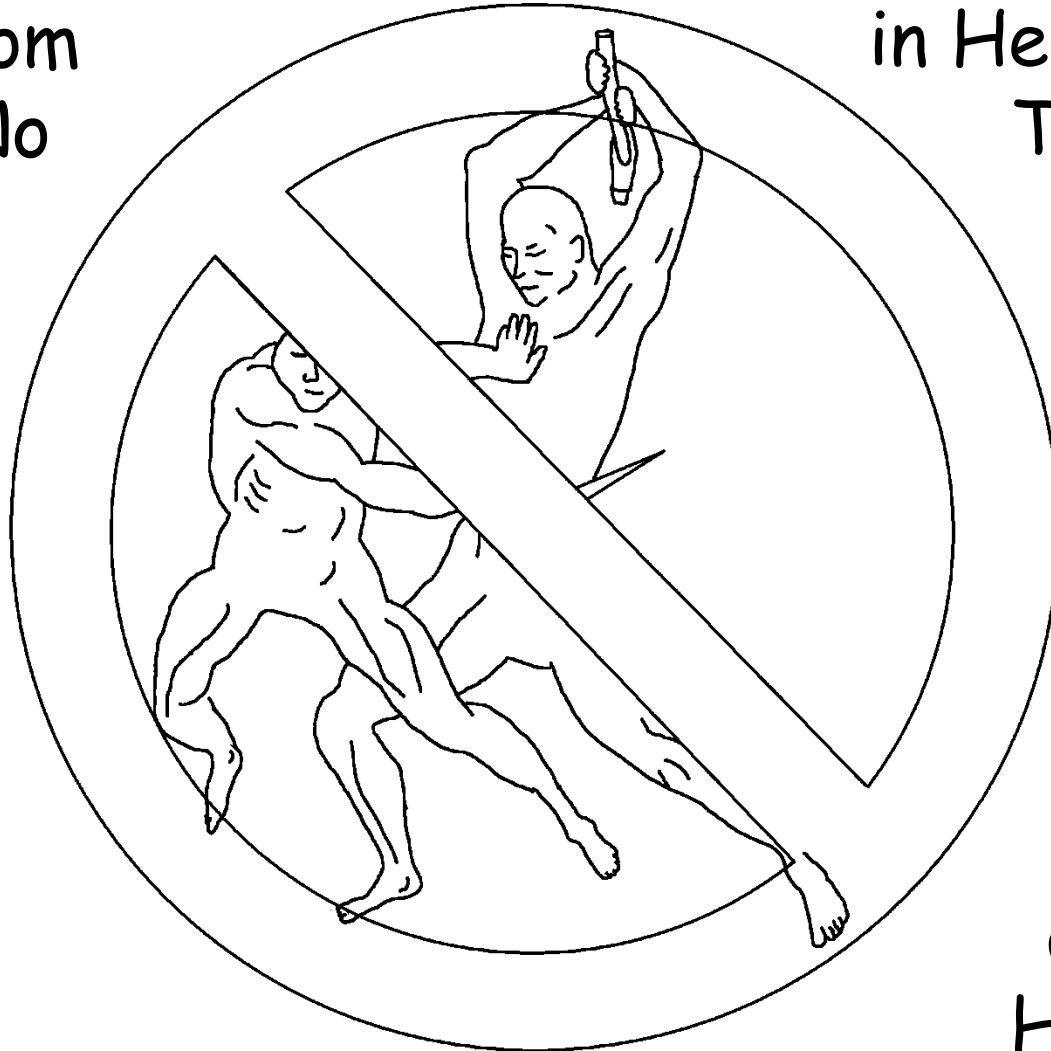

There are no locks on
the doors, because
there are no thieves
in Heaven.

There are
no liars,
murderers,
sorcerers,
or other
wicked
people.
There is
no sin of
any kind in
Heaven.



chuknohao Kaitor bai
baksa tei mokol ni
muktwi yorya. Tabuk ni
o thang sungSao Kaitor ni
bororok belai khakham
mani kisa jora rogo
kapna nango. Chuknohao,
Kaitor bebak muktwi no
huchai rohor bai nai.



Chuknohao thwimwng bo tonglak. Kaitor ni bororok
molbrum brum ni bagwi Subrai baksa wngnai. Aro
wo tei khakham mwng, tei kap mwng, tei tekto
tonglak. Kulum-kwsa,
kaklai mwng, thwi
mani bagwi kap lai
mwng tonglak.
Chuknohao bebak
no tongthogwi
molbrum ni
bagwi Kaitor
bai bak
tong nai.



Jottoni slei kaham kuk, chuknoha khe Jisu Christo no baithang ni mwthang naisa hwnwi poito khelai nai tei Bono Bugra hwnwi kok khna nai rok bebak chwla tei bwrwi rok ni bagwi (omor rajak rok ni bagwi bo). Chuknohao Mera bwsa ni bwchap hwnjak nai bwchap kang sa tongo. Abo bororok ni bumung bai supung jak. Aro wo sabo ni bumung rok swijak tong sawi de man? Jisu no poito khelai nai bebak bororok ni. Aro wo nini bumwng de tong?



Elembago chuknohano twiwi paithak ni kokthai rogo wanama singcha kobokkwnng rok tongo. "Hake Phola tei Hamjwk kwtal saw o, 'PHAIDI!' Khnai tong nai rok sadi 'Phai di!' Twi kangjak rok phai di, muchwng nai, a twi no magna nathwng."

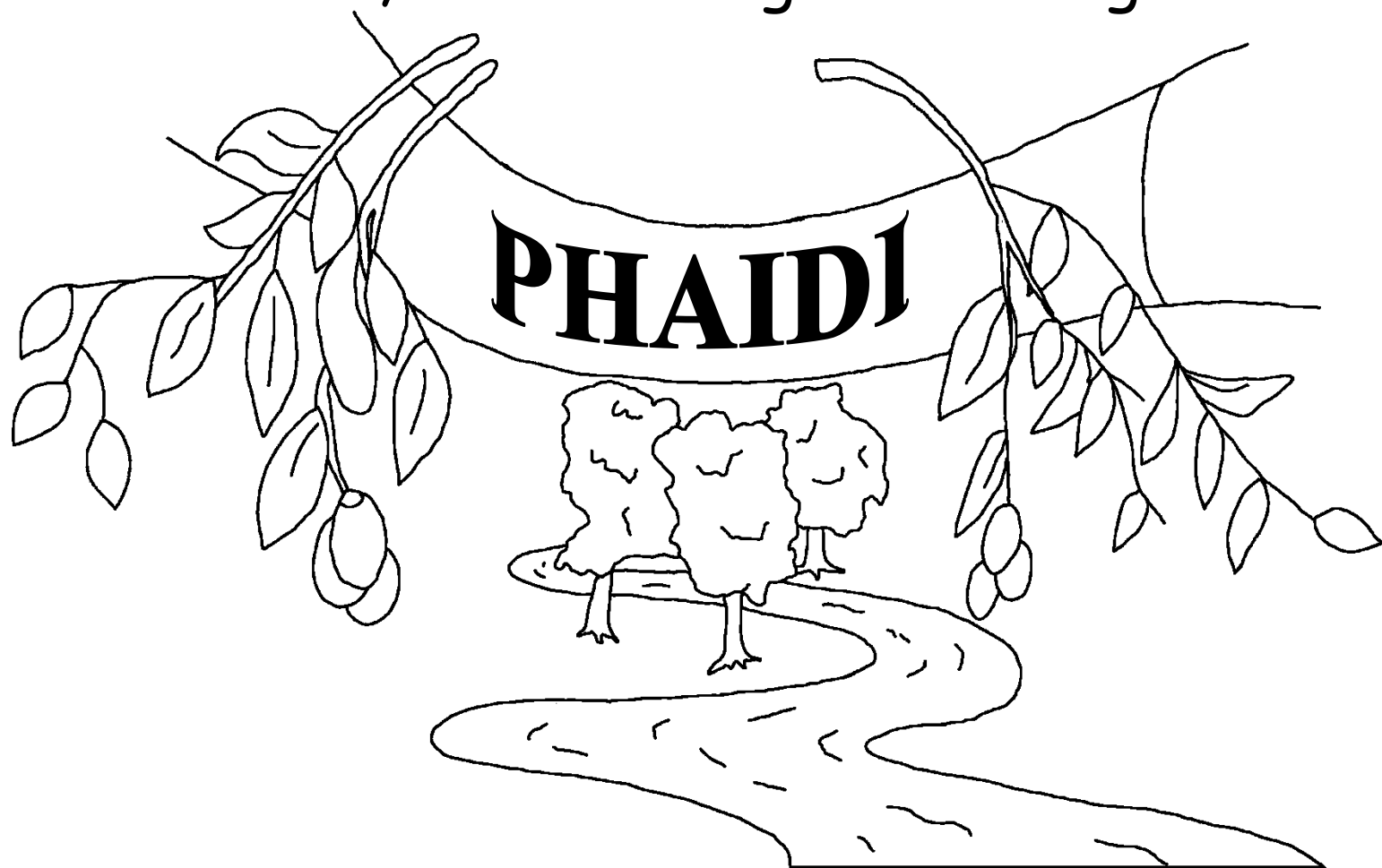

Chukha, Kitor ni naithok tongthai
A story from God's Word, the Bible,
is found in

Johon 14; 2 Korinth 5;
Phunukjakmani 4, 21, 22

"The entrance of Your Word gives light."
Psalm 119:130



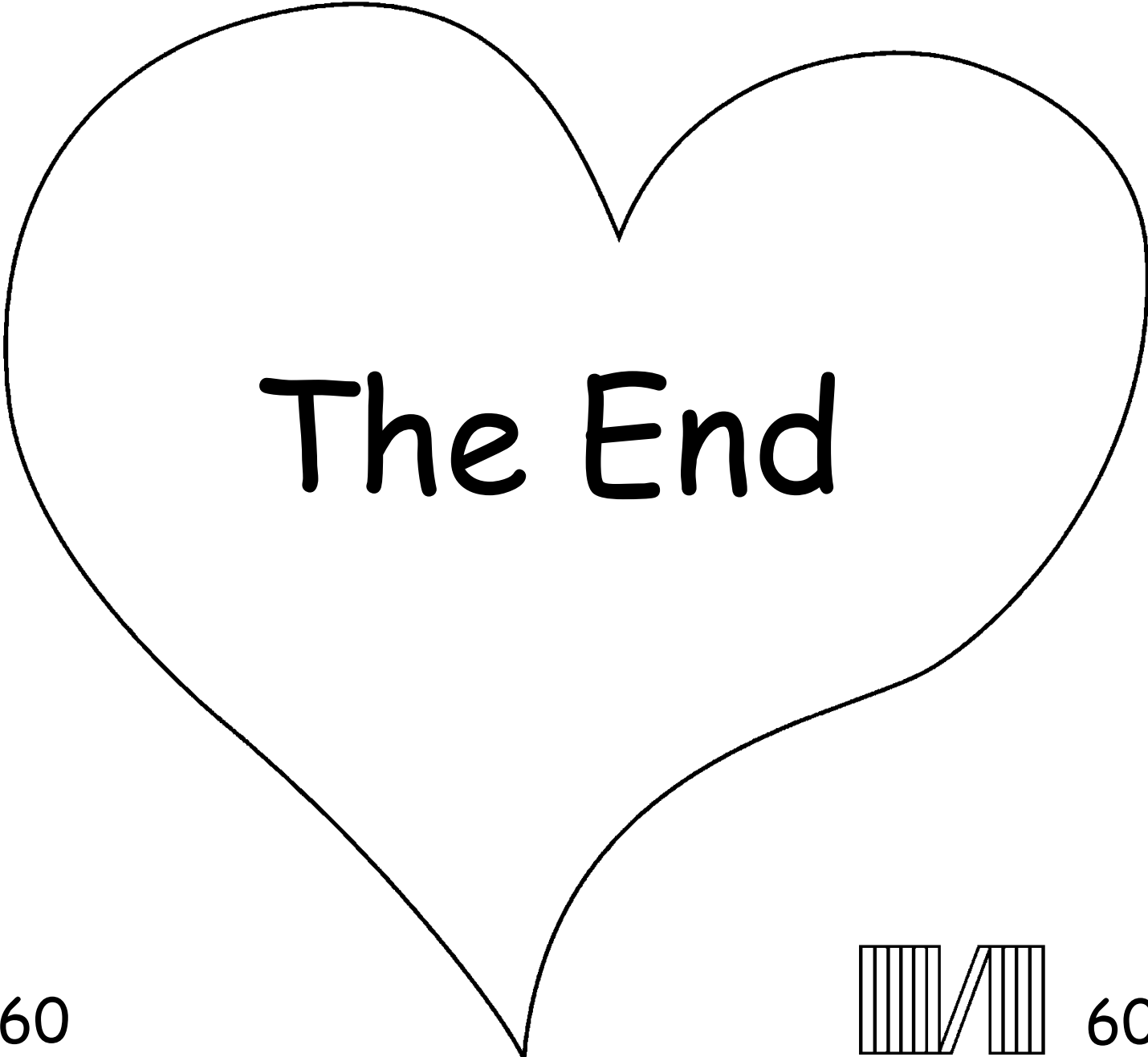

The End



I elembakni kothoma chwngno snam nai tei
norokno Bono sinirwna mwchwngnai Kaitor ni kok no sa-o.

Chwng hamya khlaikha hwnwi Kaitor sai mano, abono Bo
sumsok hwno. Sumsok ni manthai wngkha thwimwng, phiya Kaitor
nono belai khe hamjakma bai Boni masa swswng bwsla Jisu no kros
saka-o thwinani tei nini sumsokrok ni bagwi satok jak na bagwi rohor
kha. Ulo Jisu kwthang wngwi phai kha tei chuknoha-o thangkha!
Nwng Jisu no poito khelai khe tei nii sumsok nakar jakna bagwi
bono sakhe, Bo abono khelai nai! Bo tabuk nini bisingo phai wi
tong phai nai, tei molbrum brum nwng Bobai tongnai.

Nwng a kubui no poito khelai khe, abono Kaitor no sadi:
Khaja ni Jisu, Nwng no Kaitor, tei ani sumsok ni bagwi thwi na
twi borok wngwi phai kha, tei nwng tabuk haino hai kwthang wngwi
tongo hwnwi ang poito khelai-o. Ani langma-o phaijadi tei ani ani
sumsokrokno nakarjadi, tamo khe ang kwtal langma mannai, salsa
molbrum brum ni bagwi nwngbai thang nai. Nini kokno khnai tongwi
manna tei nini bagwi nini bwsa hai khe kwthang tong na
bagwi ano chubajadi. Amen.

Bible pori di tei salbrum Kaitor bai kok salai di! John 3:16

