

Mawuxowema yɔkpɔvú lé tɔn  
Só xlé

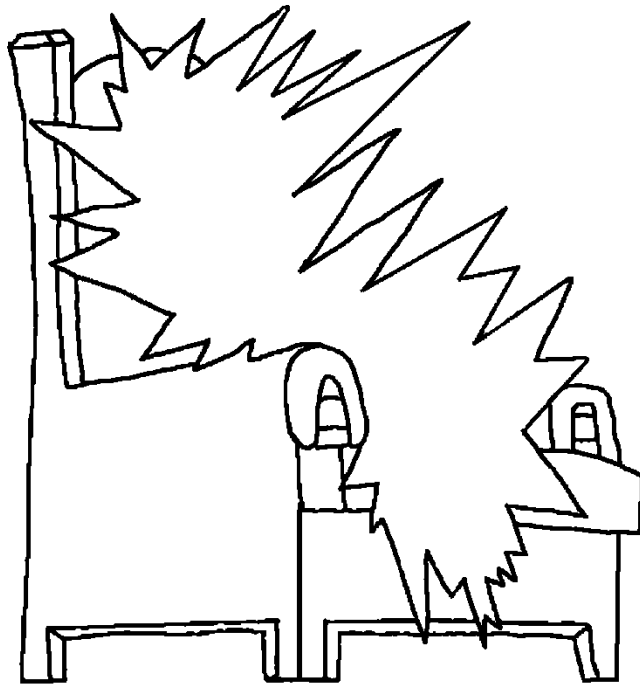

Lón, xwé  
ɔagbé ɔagbé  
Mawu tɔn



Με e wĺǎn e: Edward Hughes

Με e qè nǔ qémε e: Lazarus  
Alastair Paterson

Με e bló bɔ é sɔgbe e: Sarah S.

Με e tínmε e: [www.christian-translation.com](http://www.christian-translation.com)

Με e bló e: Bible for Children  
[www.M1914.org](http://www.M1914.org)

©2021 Bible for Children, Inc.

A qo ace bó na bló wěma elɔ sín sínmε qevo, nu a ma ko ve sá a.



Hwenu é Jezu kpoḍo ayíkúngban ó, é ḍḍ xó nú ahwanvú tḍn lée ḍó séxwé wú. É yló ó ḍḍ “Nḍten tó cé tḍn, é lé ḍḍ nú yé ḍḍ nḍten gégé we ḍḍ sexwé ... Sexwé ó lé kló bó lé nyó dekre hú ayíkúngban ji sin xwé.



Jezu dɔ: un ná yi bló tenme dó d'ayí nú mi. Nú un ko yi bló nɔten dó d'ayí nú mi vɔ ́, un ná lé kɔ wá kplá mi. Jezu yi j̄wɔ́ hwenu é e fón sin mekúkú lée me gúdo ́. Hwenu é ahwanvú tɔn lée dɔ kpínkpón e we, è só Jezu didó j̄ bɔ akpókpó dé wá bú i.

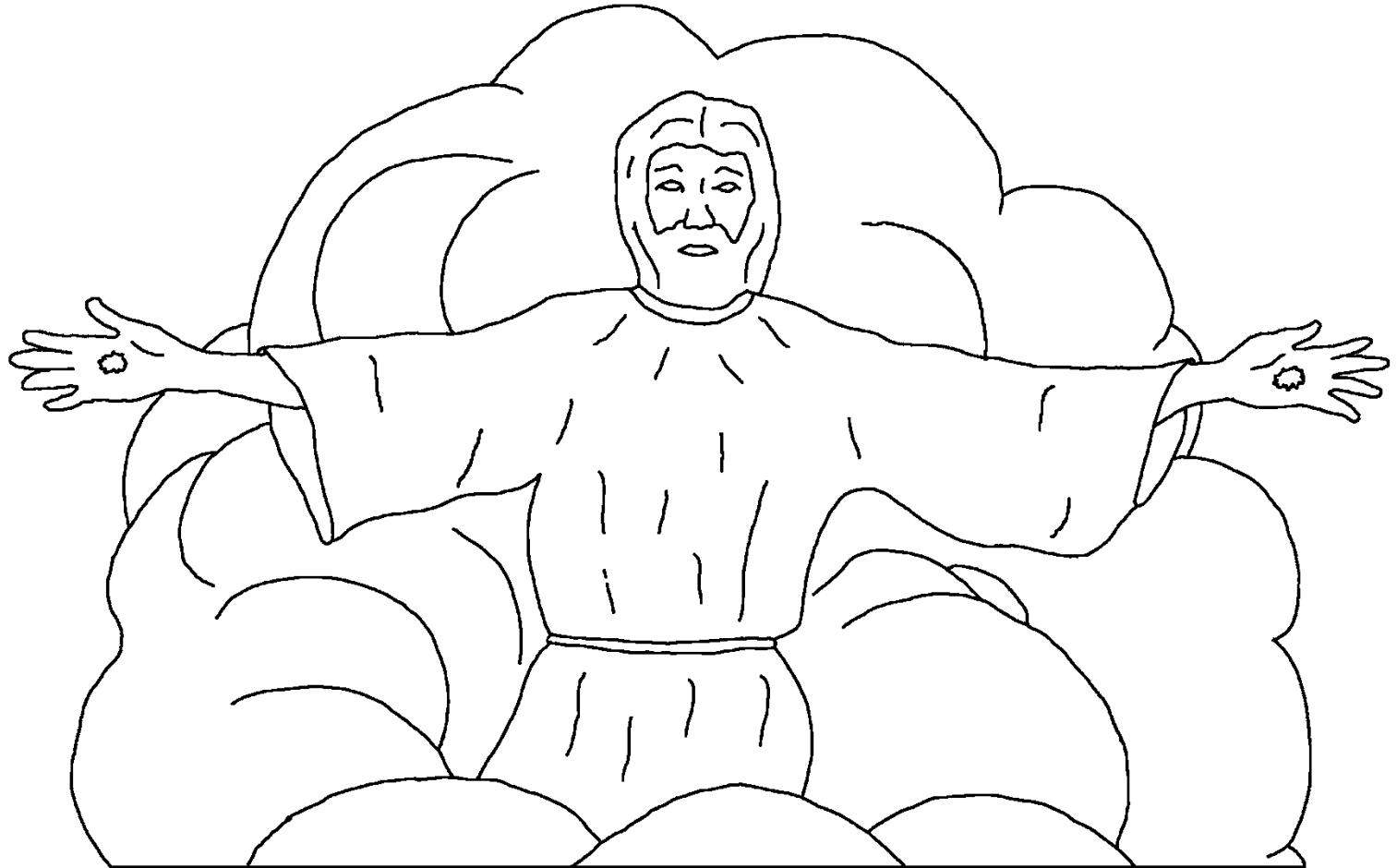

Sin hwenu ó, Mawuvi léε qo te kpɔn akpá e Jesu dó nu yě  
qo èmi ná lεkó wa ɔ. Jezu qo emi na lεkɔ wa ajǐjímε, hwenu  
e me dǐbú ma lin ǎ e. Lo ó bɔ me e ko ku din  
léε ló? Mawuxó ó qo yě qo kpɔ xá  
Jezu. È tɔn sín agbása me ɔ  
è qo kpó xá Aklúno wε.

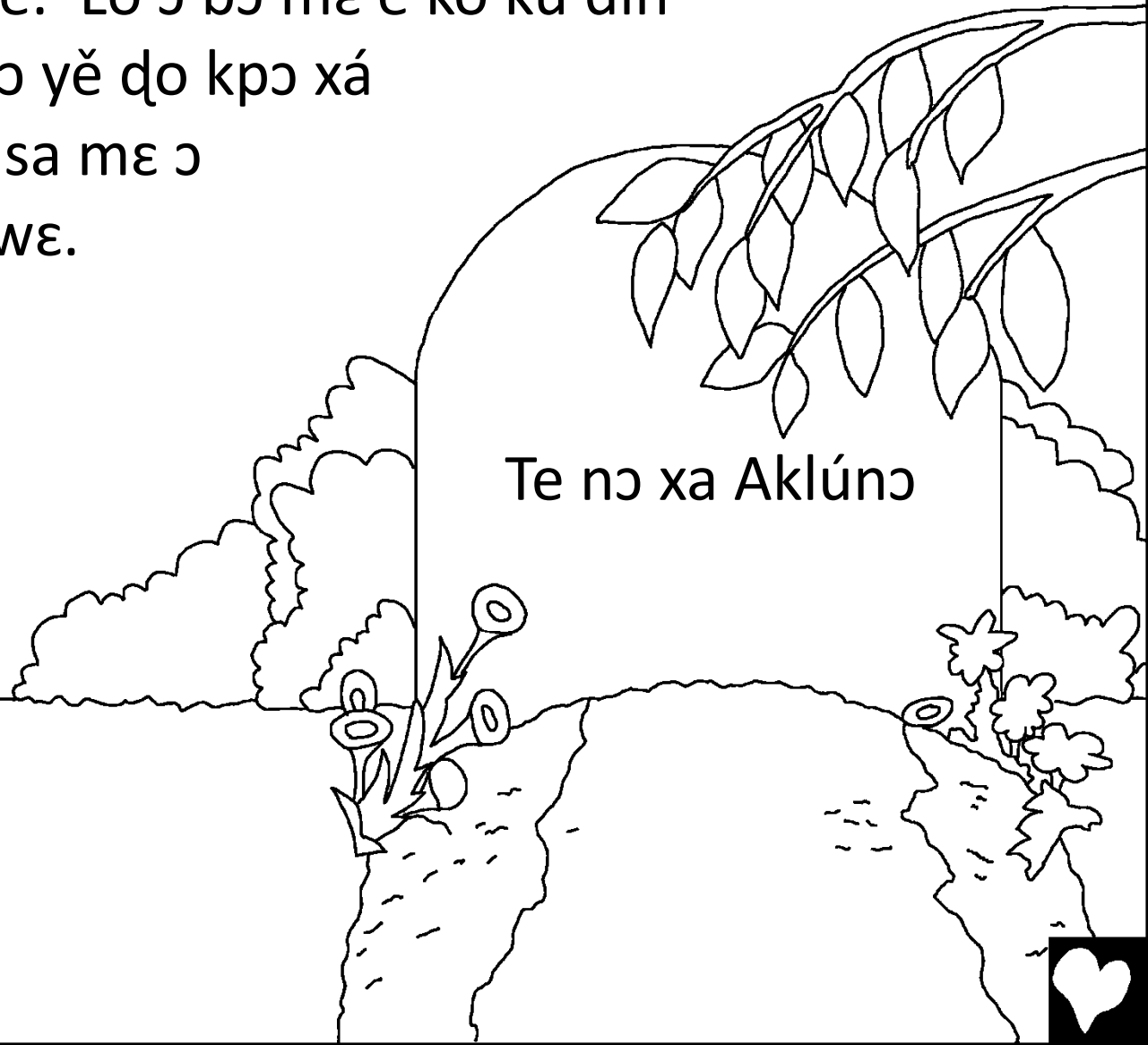

nǔdexléme, wéma gudo gudo tó mawuxówéma ɔ, ɔ́ lé e  
jĩnukúnsin nyó ɔ̀kpè gbɔn ó nǔ mi. Nû devõ e ɔ́ tají ó wε  
nyí ɔ́, ɔ́ hwenu e ɔ́ tají me ó, jĩnukúnsin lé nyí nɔ́tén  
mawu tón. Mawu ɔ́ fí bí, lo ó  
axósúzinkpo tɔn ɔ́  
jĩnukúnsin.

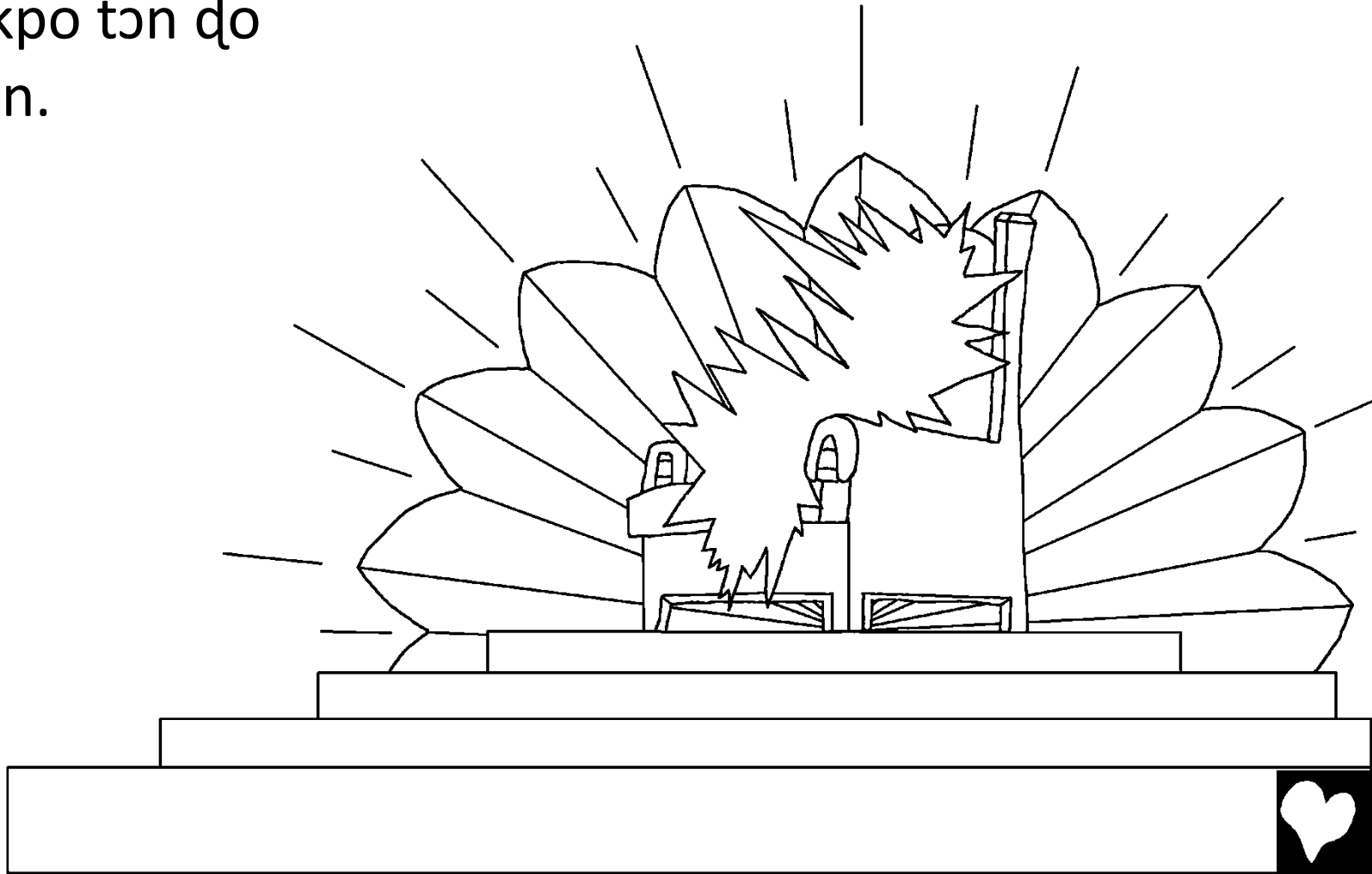

Wensagun lée kpódó me devö ée  
do j̄nukúnsin lée kpán n̄n do  
mawu s̄n we do j̄nukúnsin. Lo ɔ,  
mawu ví ée kó kú bó yi j̄nukúnsin  
lée ó b̄i n̄o blo gbon m̄ɔ. Yě n̄o do  
han ji we d̄ó kpa susu nú mawu.

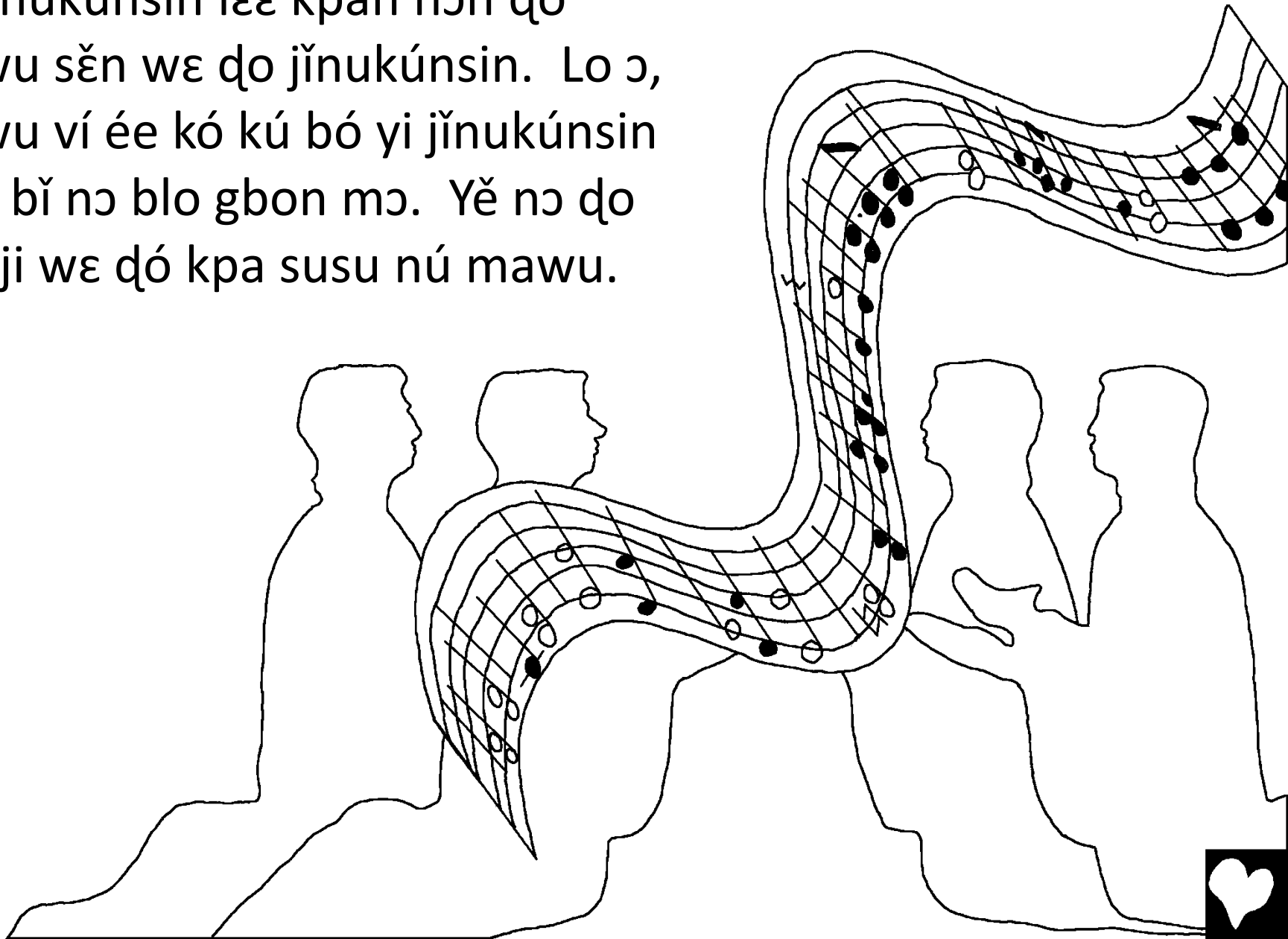

Xó ée ɔo han e ji we yě ɔé we léé ɔie: a nyĩ me e je xá bó ná  
yí wěma ɔ́, bó gba wuntun léé é, ɔó é hu we, bo gbɔn hun  
towe gbla me ɔ́, a xo gbe nú gbetó léé  
nú mawu, ɔo gbe léé bí me, ɔo  
togun léé bí me, ɔo to léé bí me.  
(Nǔɔexléme. 5:9)

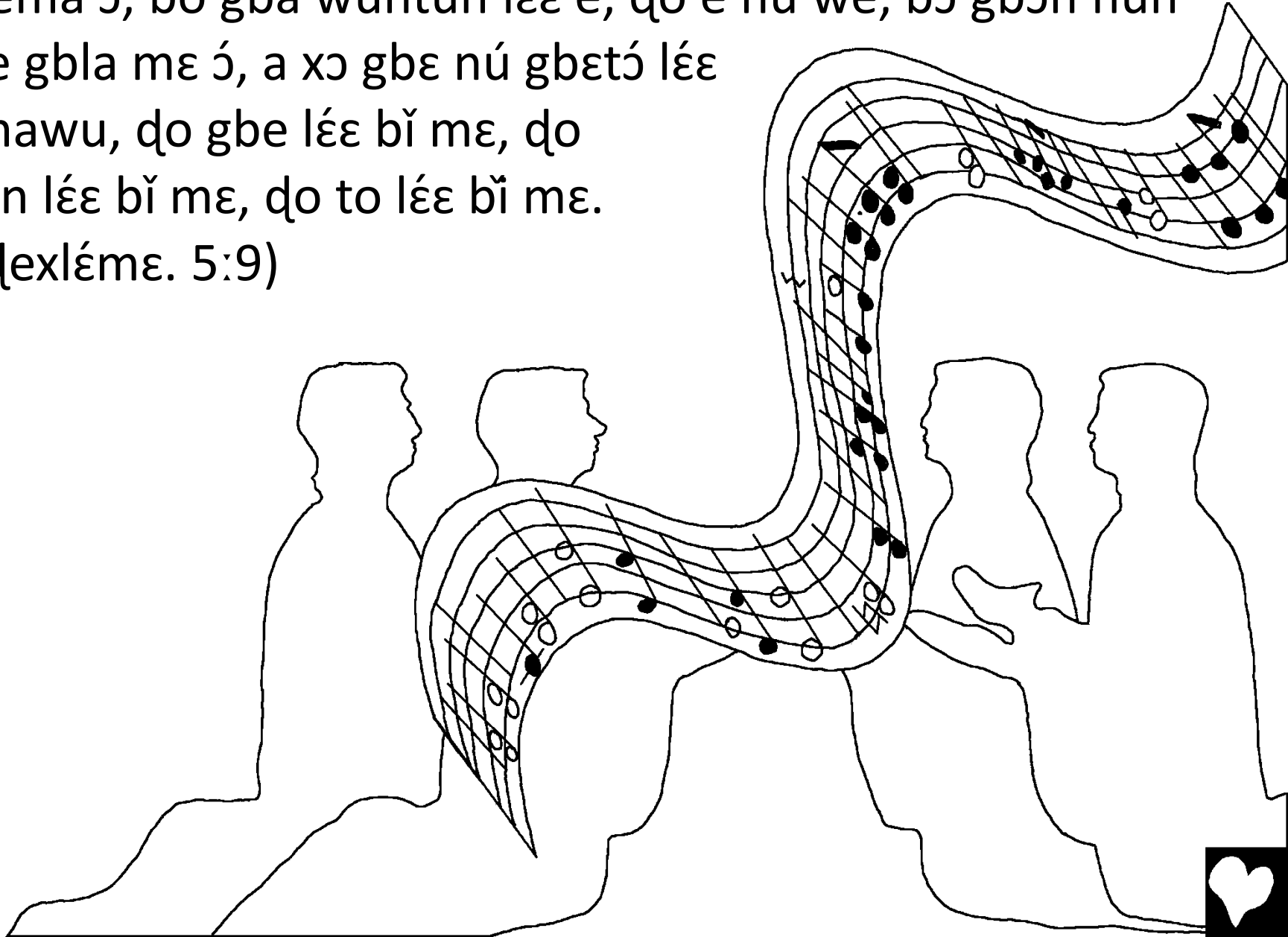



Mawuxo wéma ɔ sin vivɔnu ɔ dɛ sexwé xɛ di “Jeluzalému yǎyó”. É xɛ toxo mímé Jeluzalému e Mawu sé dó, bɔ é dɔ te je sín jǎnukúnsin wɛ ɔ mì. É dɔ susu Mawu tɔn.

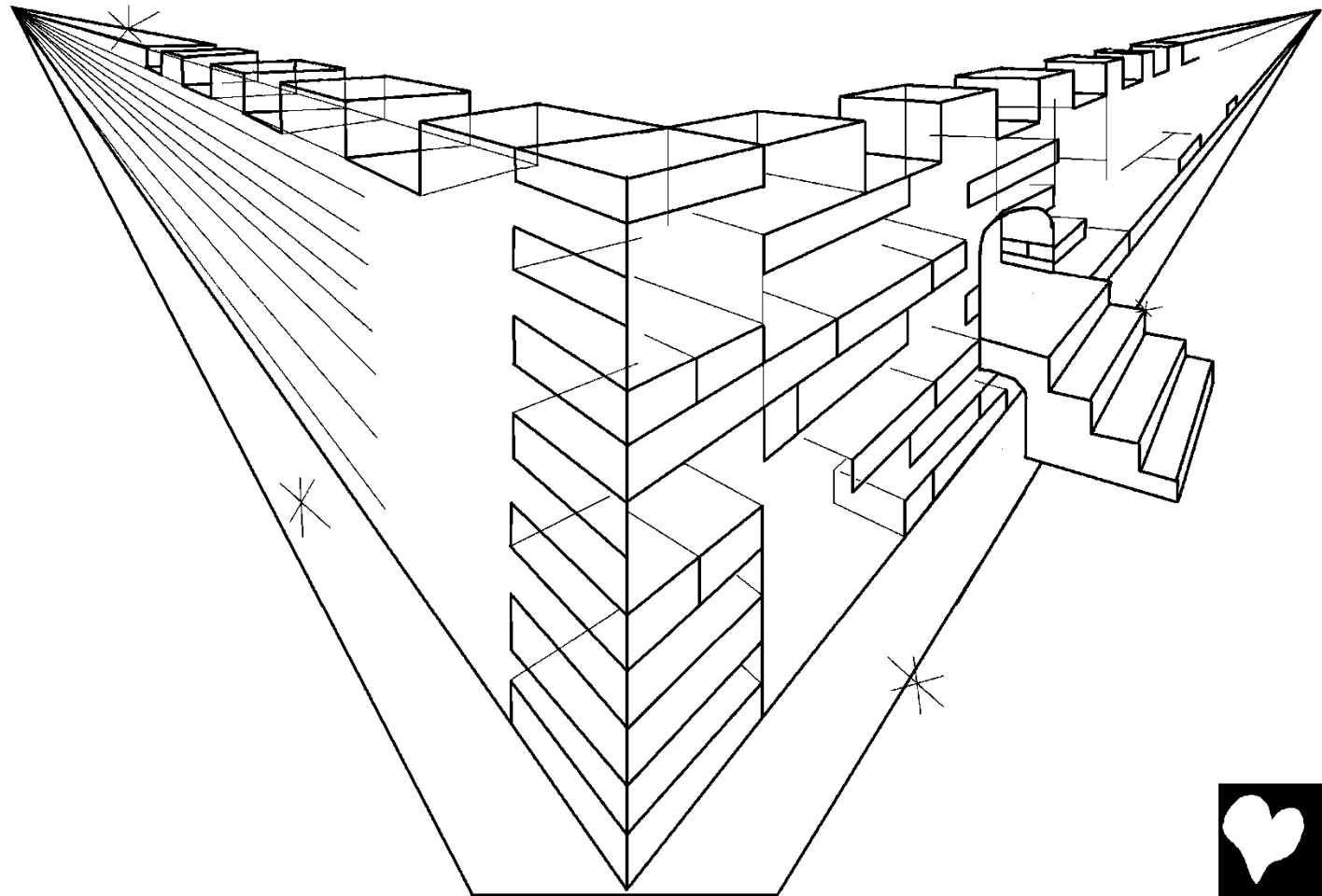

Hontogbó tɔn e é sọ sika dó bà acó ná lée nó ọọ nùvo  
hwebínu. È e mi byọ e me bo kpón me ọ, é nyọ kpón me  
nyá!!! Tòxó ọ kpodó alí e ọọ ème lée bí xwíi kro we è yí  
sika akù ọ dó bá acó ná.

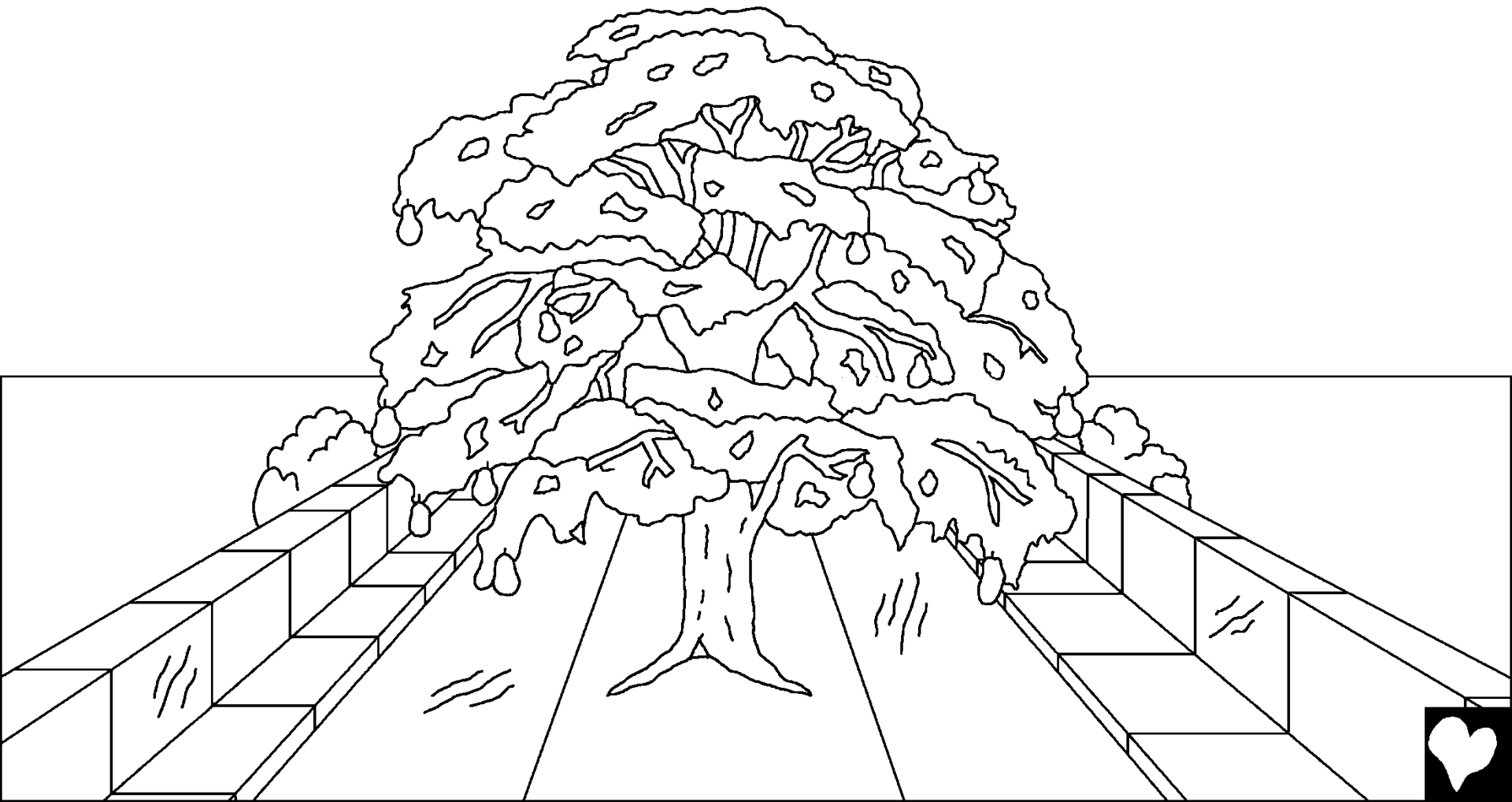

Το ɔagbé e no ná gbε με ɔ no sa sín fíin Mawu tɔn με. Atín e sínsén tɔn nó ná gbε με é, ée è mo ɔo Jikpá Edéni tɔn με τίταν ɔ ɔokpó ɔokpó ɔo tɔ ɔ sin akpá xwé we léε. Atín ɔé we bo no na sinsen donu vǒvo wǎwé, wúnme ɔokpó sún ɔokpó. Atín ɔé we bo amǎ tɔn léε no gbo azon nú akɔta léε.

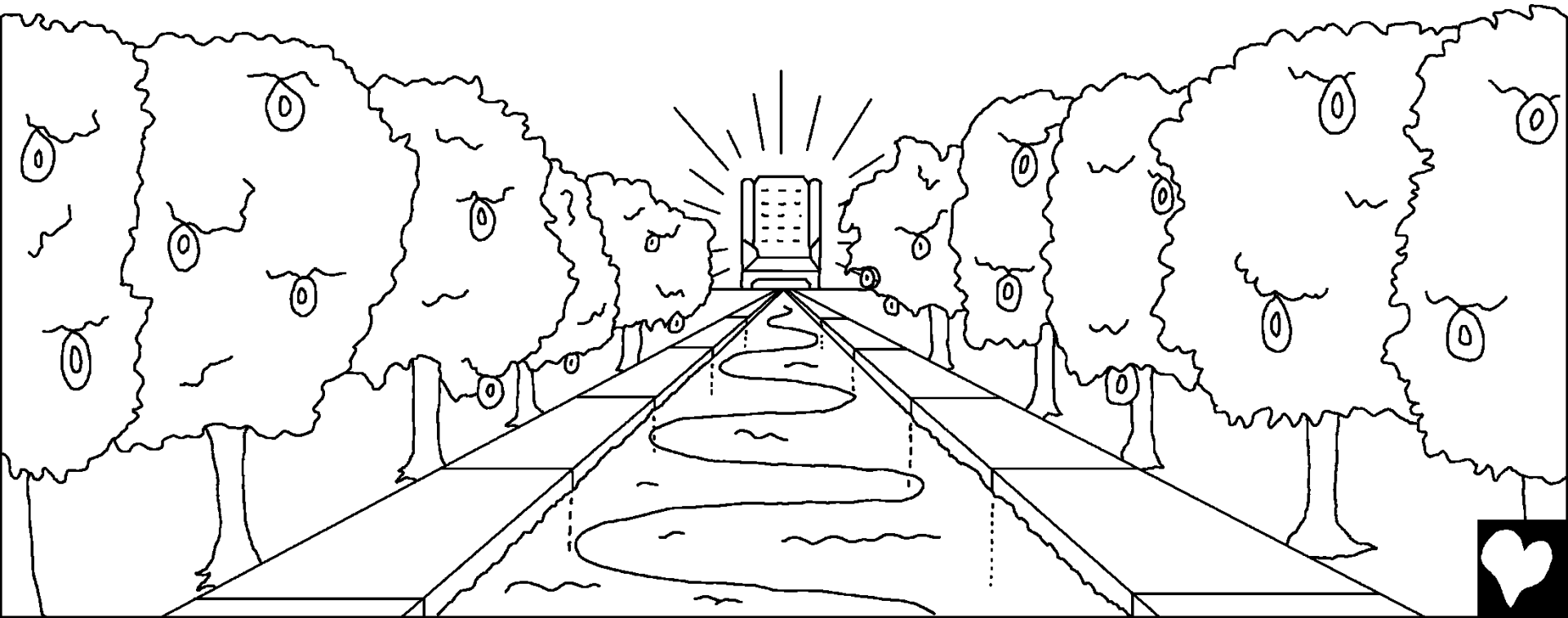

Zǎn nɔ kú ɔo sɛxwé a, ɔó gǐgó Mawu tón nó gɔ ε hwé bí nú.

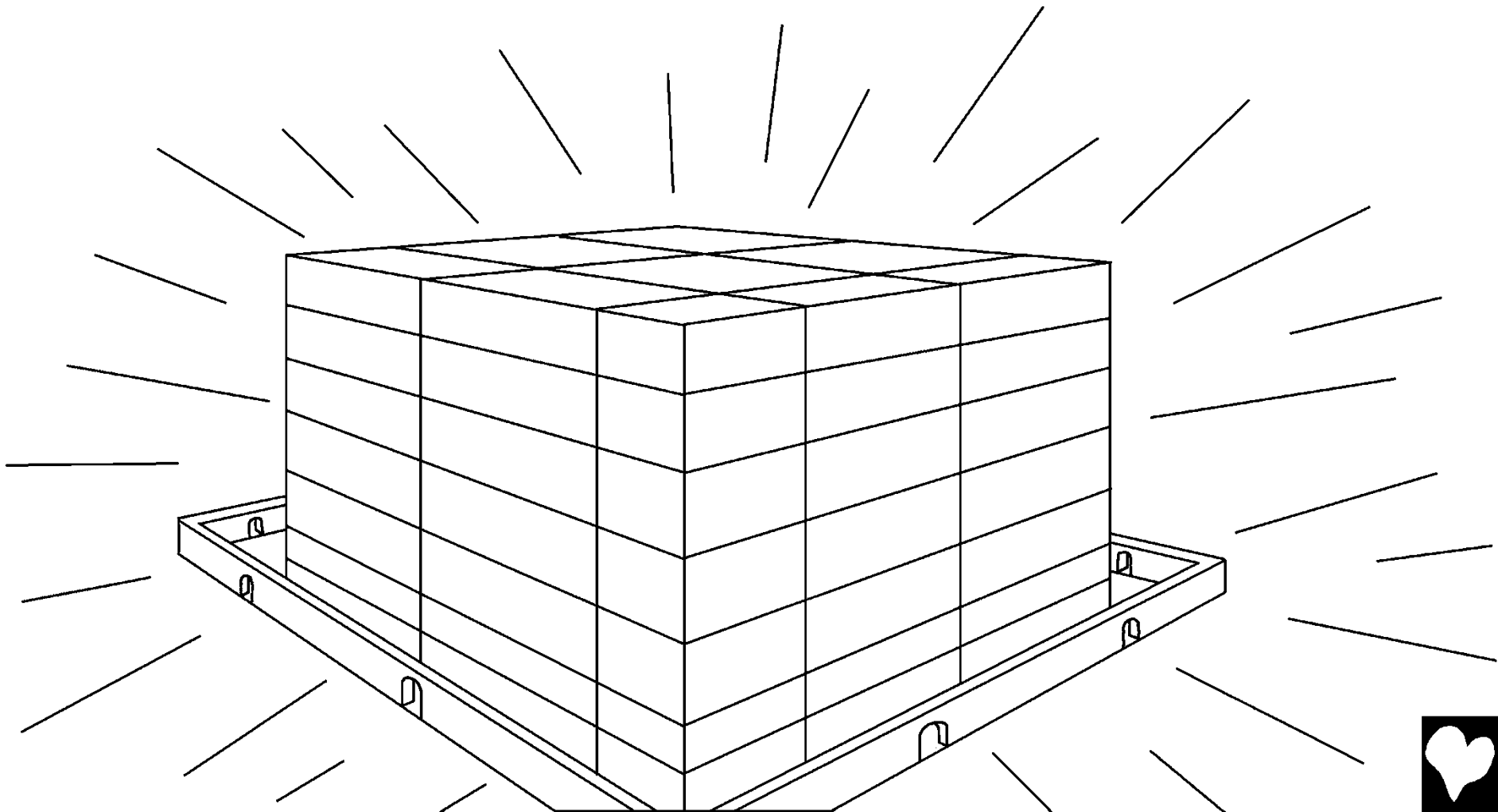

Kanlin sexwé tɔn lé bǐ wε sé tónú bo nɔ home. Xhlà lée kpo léngbɔví lée kpo nó dú amă dó kɔ́. Kinikini lée lò nó dú amă xǔxú nyíbúsu lée dɔhun. Mawu Mavɔmavɔ dɔ: yě ná gblé wu me dǎbǔ a, yě ká ná hen nǔ dǎbǔ gblé dɔ só mímé Cé ɔ me a.



Mi kpɔn sɛxwé ɔ, mi ba  
nũ dé lé kpo. Xǎmèsinsin  
xó, avũnxixo, gǎyǎyi.

Cávi ɔo hɔn ɔǎbũ jí ǎ  
ɔo ajoto ɔǎbũ ɔo sɛxwé  
a. Adíngbánnɔ, me hù  
tó, azétó abí mɛdídá  
ɔǎbũ ɔo sɛxwé a.  
Ylándó alɔkpa ɔǎbũ  
ɔo sɛxwé a.



ᐃᑦ ᐱᑦ ᐱᑦ ᐱᑦ ᐱᑦ ᐱᑦ,  
ᐱᑦ ᐱᑦ ᐱᑦ ᐱᑦ ᐱᑦ ᐱᑦ ᐱᑦ  
ᐱᑦ ᐱᑦ ᐱᑦ ᐱᑦ ᐱᑦ ᐱᑦ  
ᐱᑦ ᐱᑦ ᐱᑦ ᐱᑦ ᐱᑦ ᐱᑦ.  
ᐱᑦ ᐱᑦ ᐱᑦ ᐱᑦ ᐱᑦ  
ᐱᑦ ᐱᑦ ᐱᑦ ᐱᑦ ᐱᑦ.



Kú t́ín ọ̀ lòn a, Mawu ví lée ná ọ̀e xa Aklunó tẹ̀gbẹ̀, tagba só t́ín a, aví só t́ín a, wǔ̀ve só t́ín a, Azòn, kínklan, cyo só t́ín a. ọ̀ lòn ọ̀, nǔ nyo nú Mawu ví lée bí ọ̀ kpó xa Mawu.





Ée nyò xú bí e, sɛxwé ɔ, mɛ bí tón wɛ; súnnuvi, nyónuvi kpró mɛxo kpró bí e yì Jezu klísu dī Mɛhwɛngántó yětɔn lobo nɔ se tonu ní dī Aklunó yětɔn e. Do lón dón ɔ, wɛma dé de bo è yɔ dɔ Gbéwɛma lɛngbóní ɔ tón, bo gbɛtó mókpan sin nyíkɔ wɛ dɔ émɛ. Mí tunwun nyíkɔ e dɔ émɛ lée e a? Gbɛtó e só gbɛ yětɔn nǔ Jezu lée wɛ.

Nyíkɔ mí ló tón  
dɔ émɛ a cé?

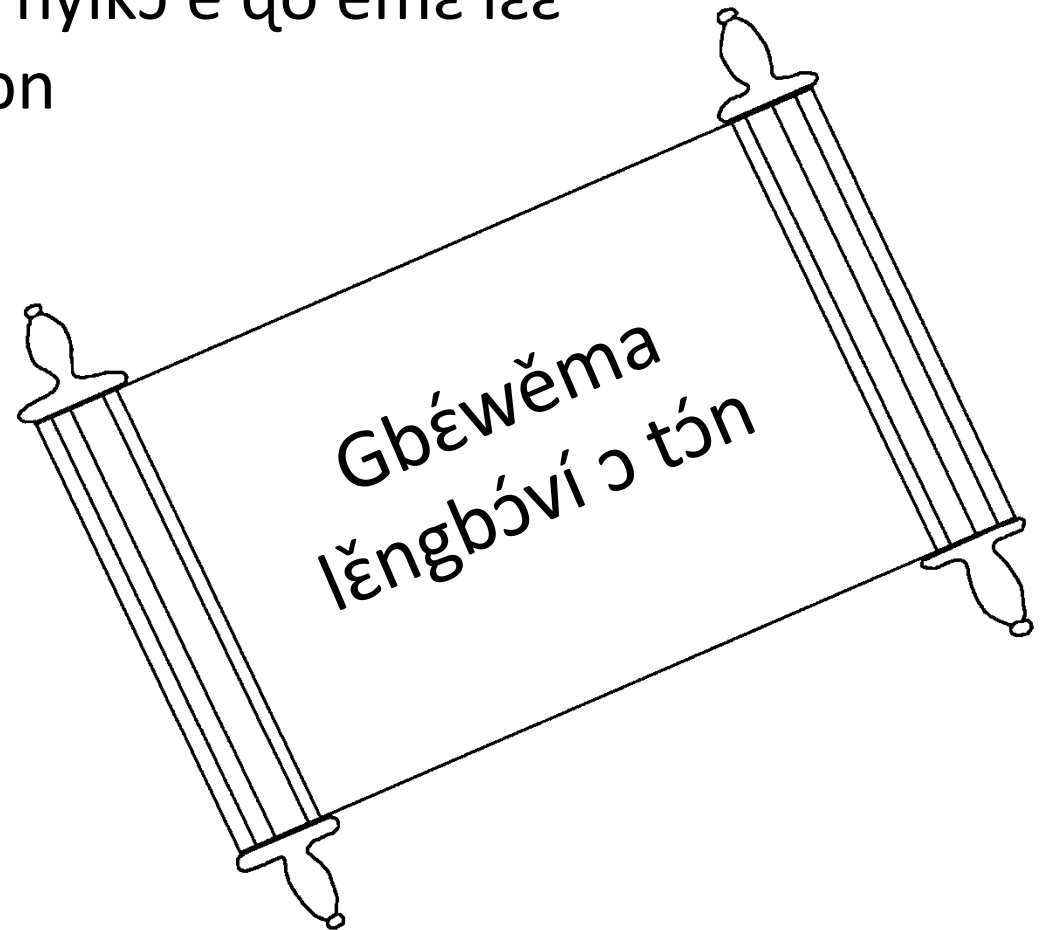

Xó gǔdo tɔn Mawuxó wéma ɔ tɔn ɔo sexwè jí ɔ, yľ dagbé  
ɔé we. “Ye ɔ kpo yawó yǔyó ɔ kpo ɔo dido we ɔ: ‘Wǎ!’ Me  
e ɔo mǔ se we ɔ lo ní ɔ: ‘Wǎ!’ Me e sinnugblá sin ɔ ní wá;  
Me e ɔo sin e no ná gbe me ɔ ba we ɔ ní yí vǔnu.”

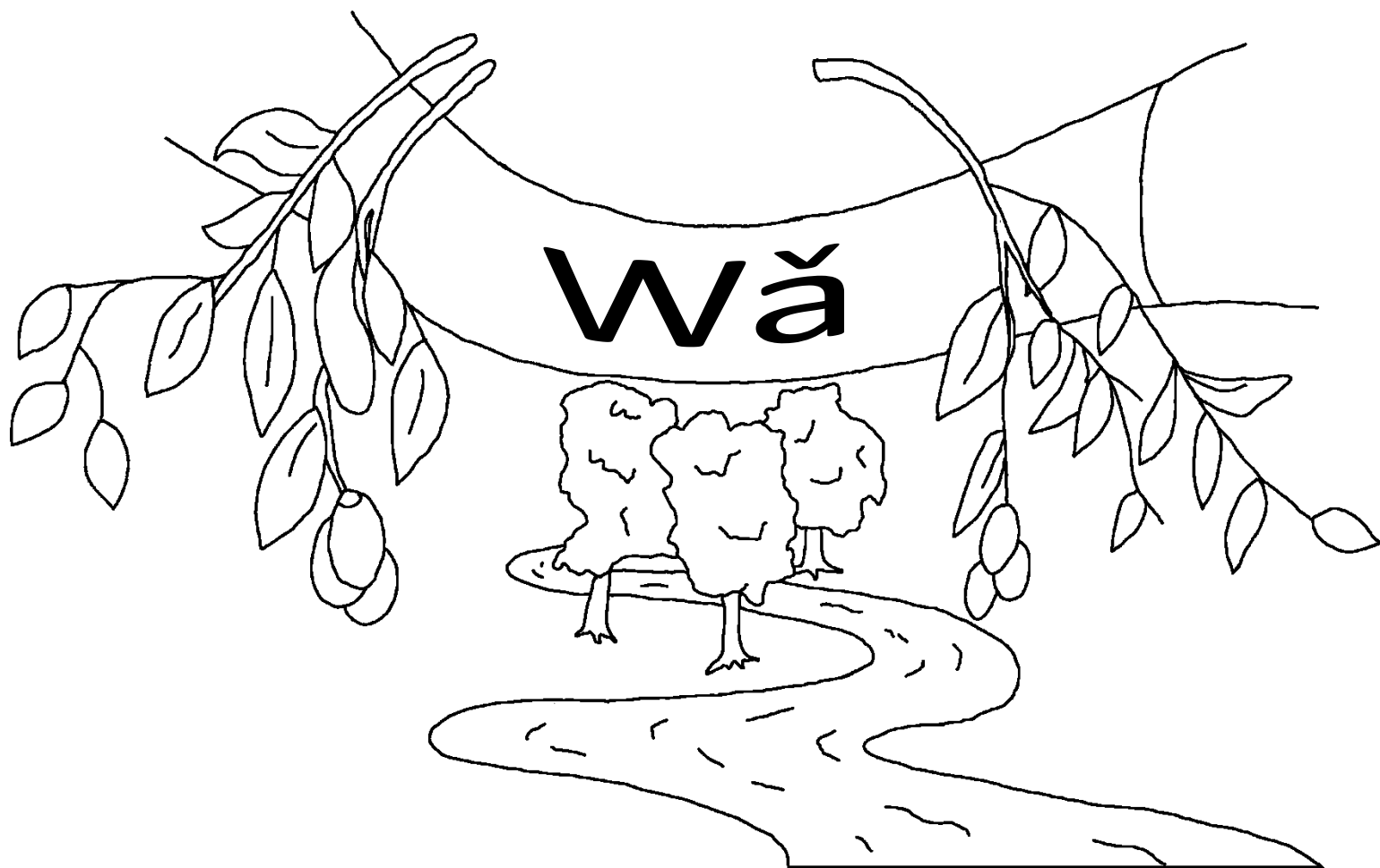

Lón, xwé ɔagbé ɔagbé Mawu tɔn

Mawuxo sín tán ɔokpó, mawuxowema

è mɔ ɔó

Jăan 14; 2 Koléntinu 5;

Nũdexléme 4, 21, 22

“Xó towe yiyí ɔ nɔ na me wěziza.”

Ɖehan kan-atɔn e hwe ɔokpó yi je kan-atɔn-wǒ



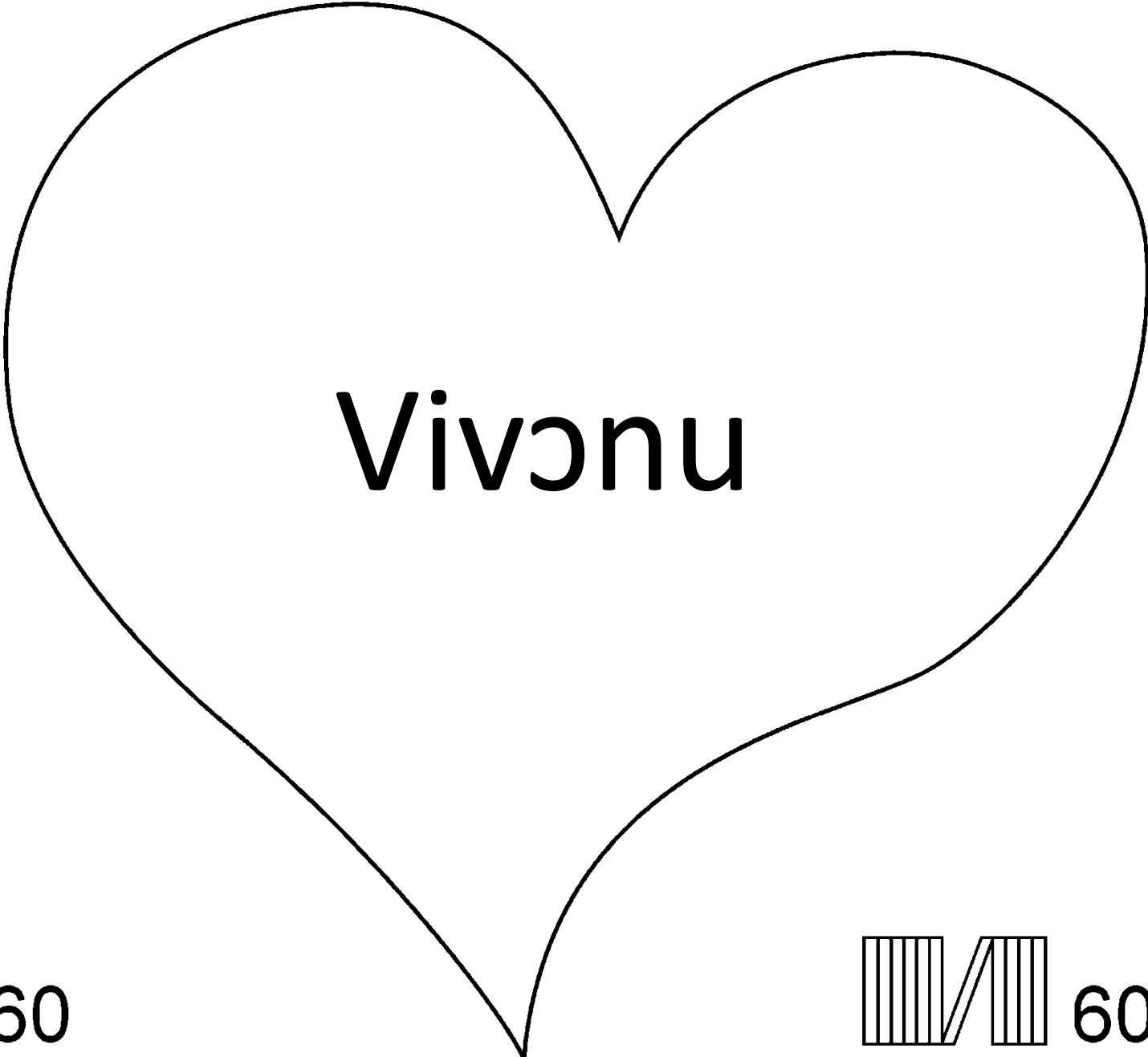

Vivonu



60

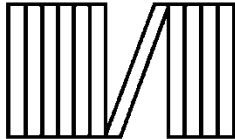

60



Mawuxó wèma éló ɔ́ xó nú mǐ dó Mawu  
mǐtɔn nǔ búdo ée dá mǐ lǒbo ba ɔ́ mǐ ni tunwun émi ɔ́ wú.

Mawu tunwun ɔ́ mǐ wa nǔ nyanya e é yló ɔ́ hwe é. Hwe sin bà e nɔ  
xò mé ɔ́ we ka nyí kú. Lo ɔ́ Mawu yí wǎn nú we sɔ mǎ, bó sɔ Vĩɔokpónɔ  
tɔn Jezu jó bɔ é ku ɔ́ akluzu jĩ bɔ ku tɔn sunsun hwe towe léé sin kɔ nú  
we. Jezu ka le fón sin ku, bo yi jǐxwé! Nú a ɔ́ nǔ nù Jezu bo byɔ e ɔ́ eni  
jó hwe mǐtɔn léé nú mǐ ɔ́, é ná jó yě nú we. é ná nó gbe ɔ́ hwe mén  
dín, lobo hwe lómɔ ná nó gbe kpódó eye kpó kǎká yí mavɔmavɔ.

Nú a ɔ́ nǔ ɔ́ núgbó we hǔn, ɔ́ xó éló nu Mawu:

Aklunó Jezu, ún ɔ́ nǔ ɔ́ hwe we nyí Mawu, bó À hǔzú gbetó bo wa  
kú dó hwe cé léé sin tamè, bɔ dín ɔ́ À le ɔ́ gbe. Un ɔ́ vǐve we we, byɔ  
gbézan cé me bo sɔ hwe cé léé ke mǐ. Enè ɔ́ un ná mó gbe yǎyó dǎvó yi,  
bɔ gbe ɔ́kpó ɔ́ un ná wa nó kpɔ xá we kǎká yí mavɔmavɔ. Dò alɔ mǐ  
bónú má se tónú nǔ we lobo nó gbe nú we, ví towe dǎ lǎe dɔhun. Amǐ.

Nó xà Mawuxó wèma bo nó ɔ́ xó xá Mawu  
ayíhɔngbé ayíhɔngbé! Jǎan 3:16

