

Angāngshinggi Bible

Khudol Tamjari

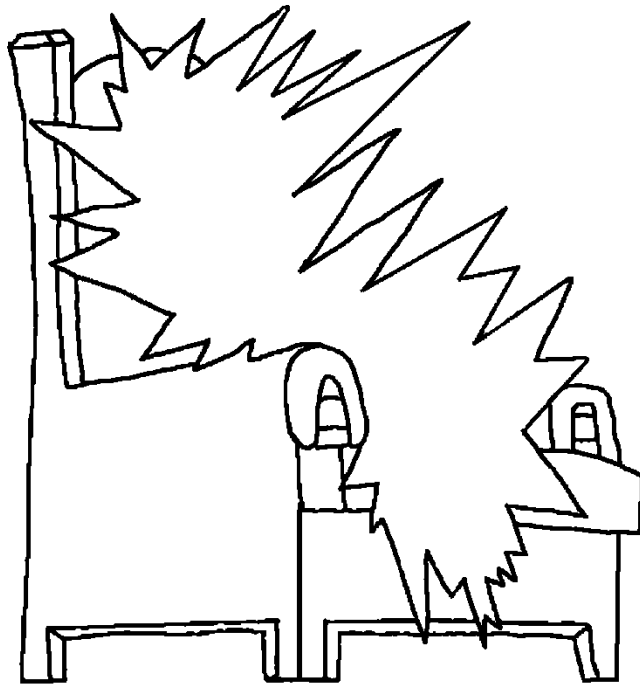

Shembiba
Mapugi
Ningthijaraba
Yum,
Sorāren



Aiba: Edward Hughes
Ayekpa: Lazarus; Alastair P.
Shemdokpa: Sarah S.
Handokpa: Madhuchandra Moirangthem
Puthokpa: Bible for Children
www.M1914.org

BFC
PO Box 3
Winnipeg, MB R3C 2G1
Canada

©2021 Bible for Children, Inc.
Ayāba piba: Lāirik machākshing asi nahākna namthokpa yāi
adubu yonduna shendān lambi oina shijinnaba yāde.



Jishu na tāibangpānda leiringeida mahākki
tung-inbashingda sorāren-gi maramda wāri
libirammi. Madu mahākna "eigi
ipāgi yum" hāina koukhi, aduga
mapham aduda ka yāmna
yāoba yumjāoshing
lei hāirammi. Yumjāo
adu yāmna chāo-i,
yāmna phajei.

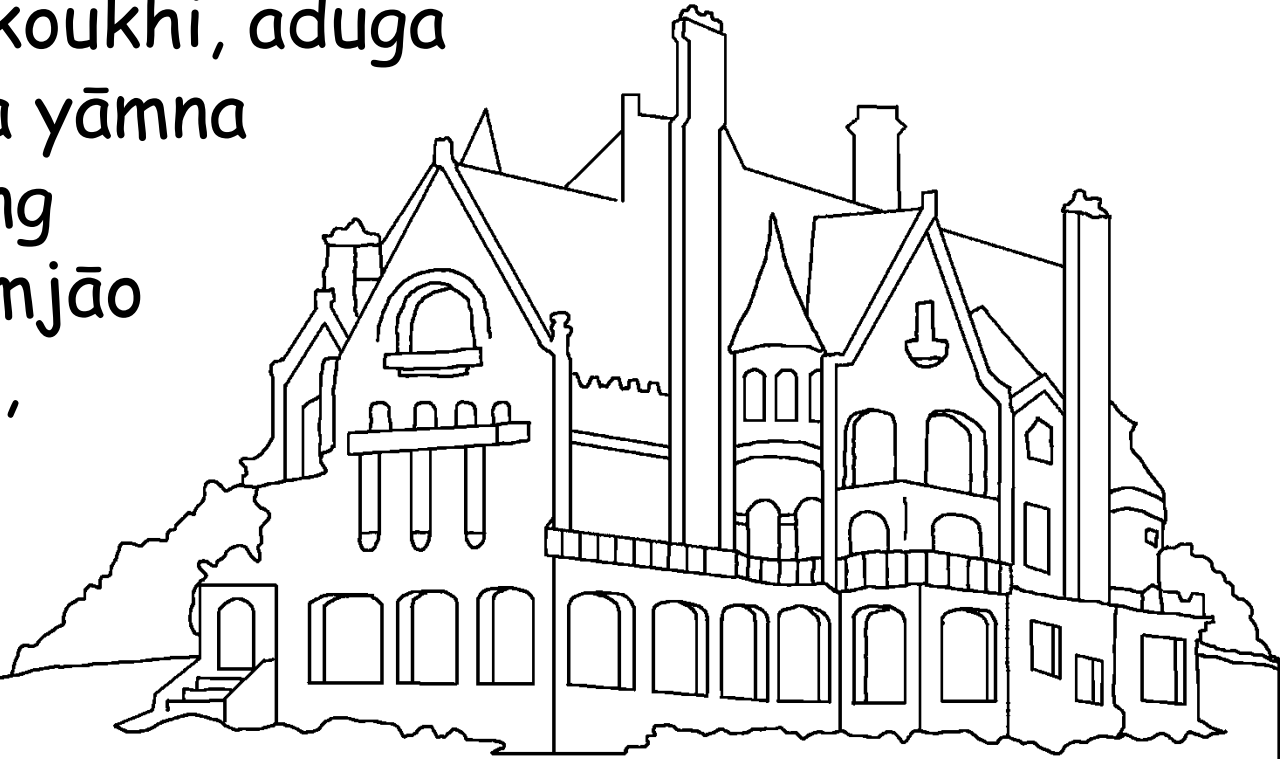

Sorāren yāmna chāo-i amasung tāibangpānda
leiriba yumdagi phajaba yāmna helli.



Jishu na hāi, "ei nakhoigi damak mapham thourāng
touba chatli. Aduga eina nakhoigi mapham thourāng
touba chatlabadi, ei amuk lāktuna nakhoibu eigi
nākta leiminnanaba tarāmna loushin-gani".

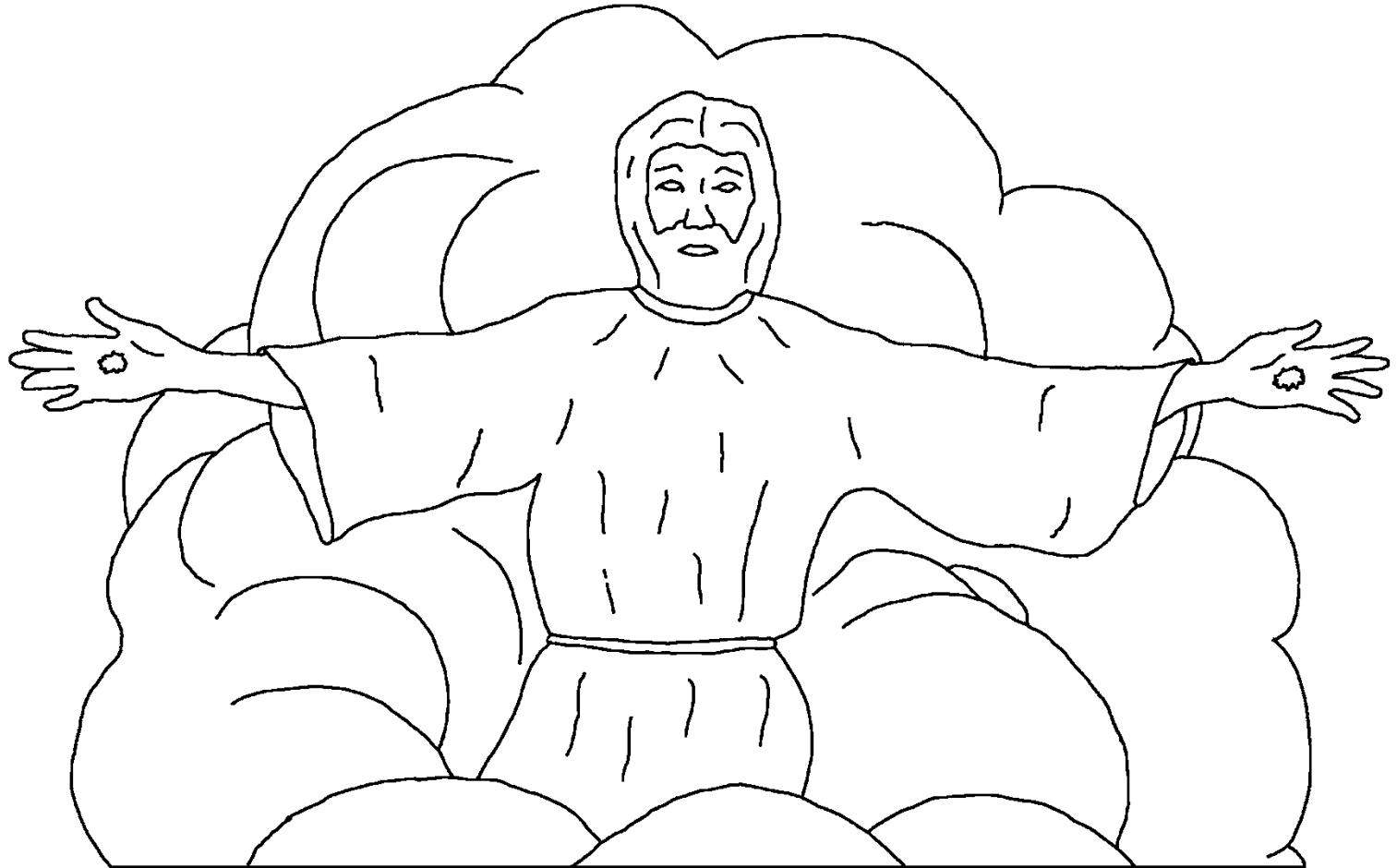

Jishu shibadagi hinggatlabam matungda sorārenda chatkhi. Jishu na sorārenda chatpa amasung leichil marakta changkhiba tung-inbashingna uhou-i.

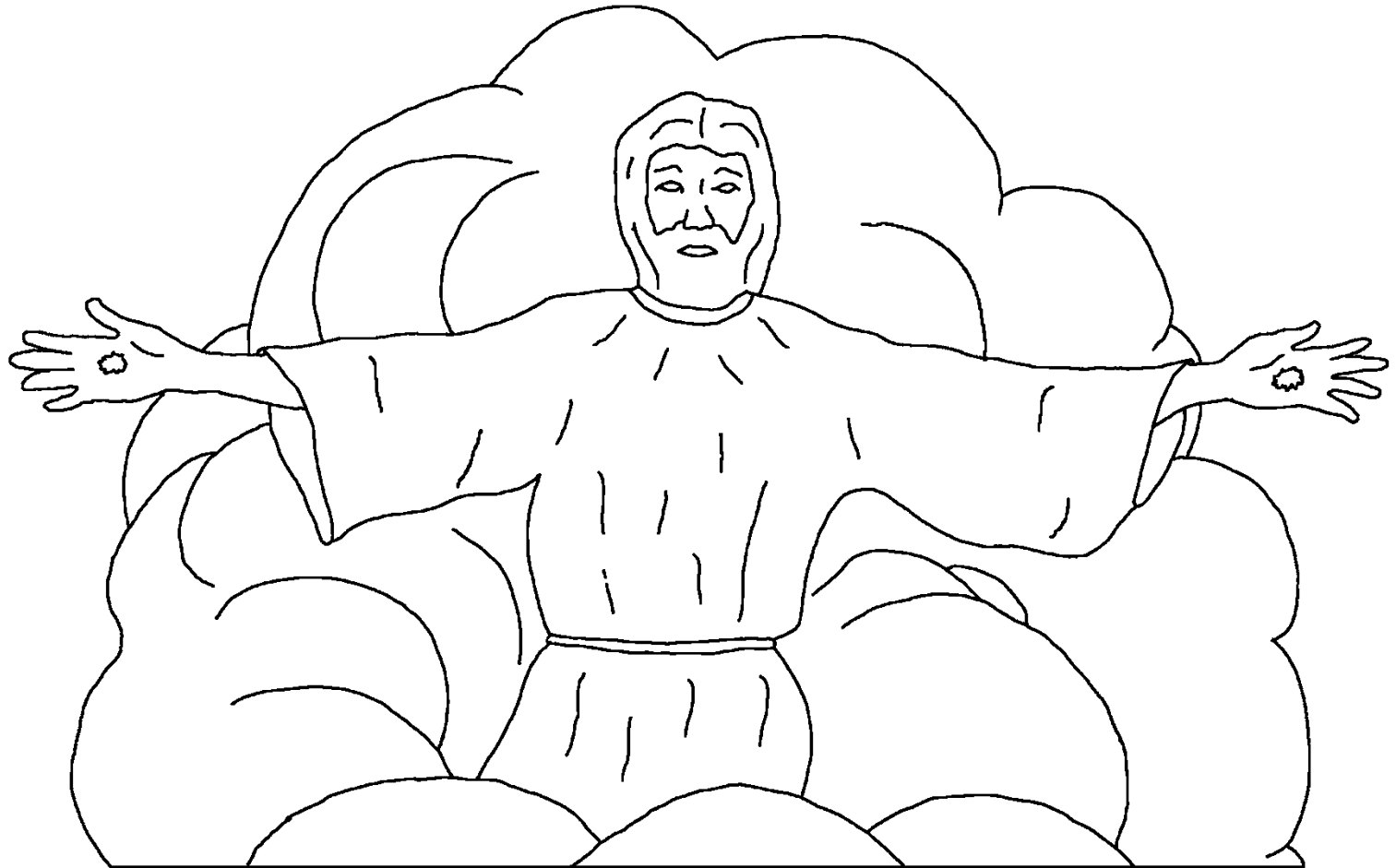

Matam adudagi, Christian shingna Jishu amuk
makhoibu louba lākkani hāina wāshaklamba adu
ningshingduna lei. Jishu na hāirammi,
khanghoudana thājadaba matamda
mahāk shoidana lākkani hāina
Jishu na hāirammi. Adubu Jishu
lāktringeida shikhiba Christian
shing kari oigani? Bible
na hāi, makhoi Jishu
ga hakthengnana
leiminnarugani.
Hakchāngdagi
tongānba hāibasi
Shembiba Mapuga loinana
leiminnaba hāibani.

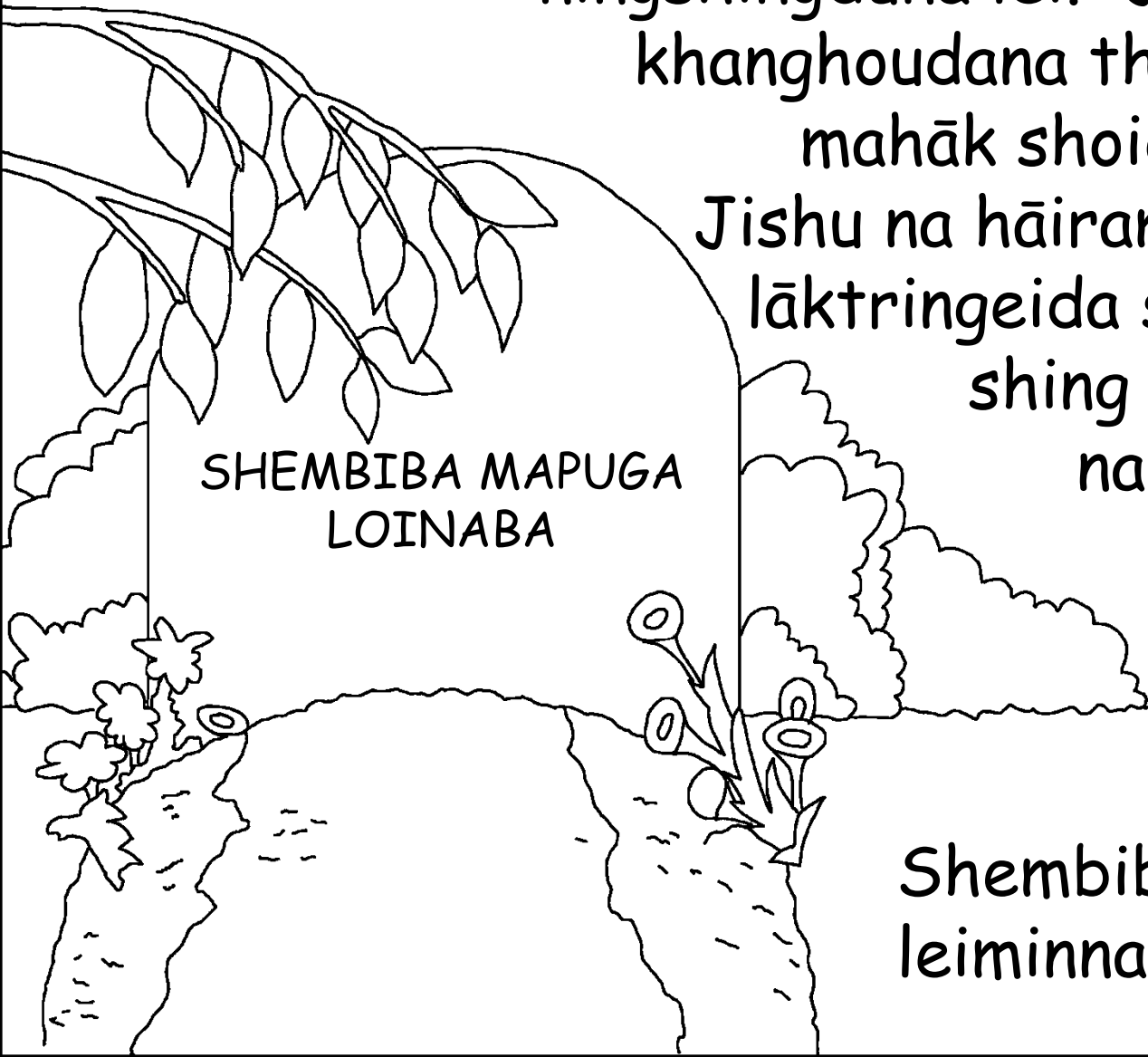

SHEMBIBA MAPUGA
LOINABA



Bible gi aroiba lāirik phongdokpibada sorāren-gi
maramda marik chumna tāki. Khwāidagi ngakpa
amasung maru oiba wāphamdi, sorāren asi Shembiba
Mapugi yumni. Shembiba Mapudi mapham khudingda

lei adubu mahākki
phambāldi
sorārenda lei.

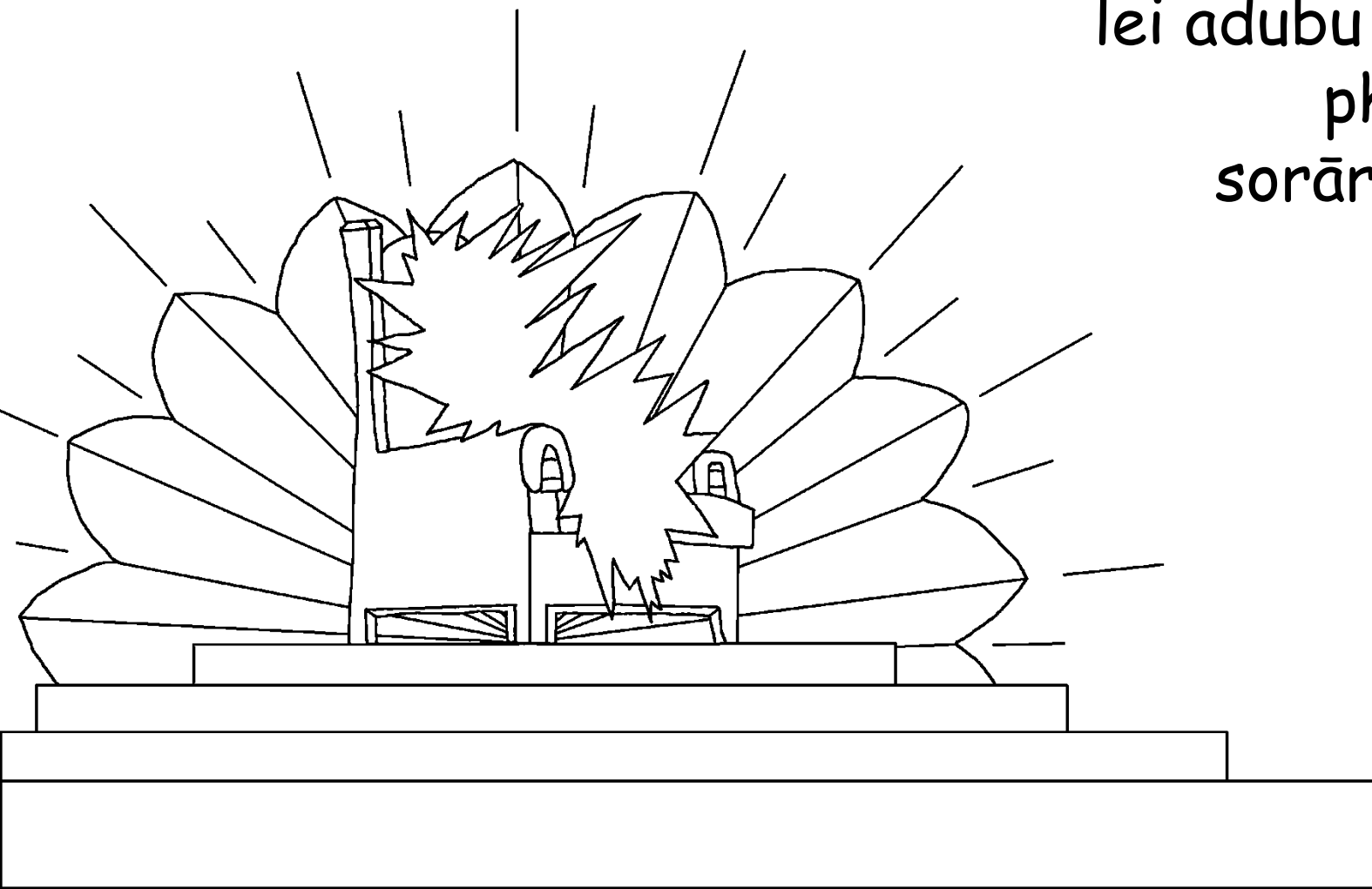

Sorāren-gi manāishing amasung sorārenda
leibashingna Shembiba Mapu khurummi.

Maduga mānnana Shembiba Mapugi

shikhraba sorārenda kākhraba
mishingsu khurummi. Makhoina

Shembiba Mapuda phajaraba

thāgat ishei shak-i. Makhoina

shakliba ishei

amagi mayekna

asumna hāi:

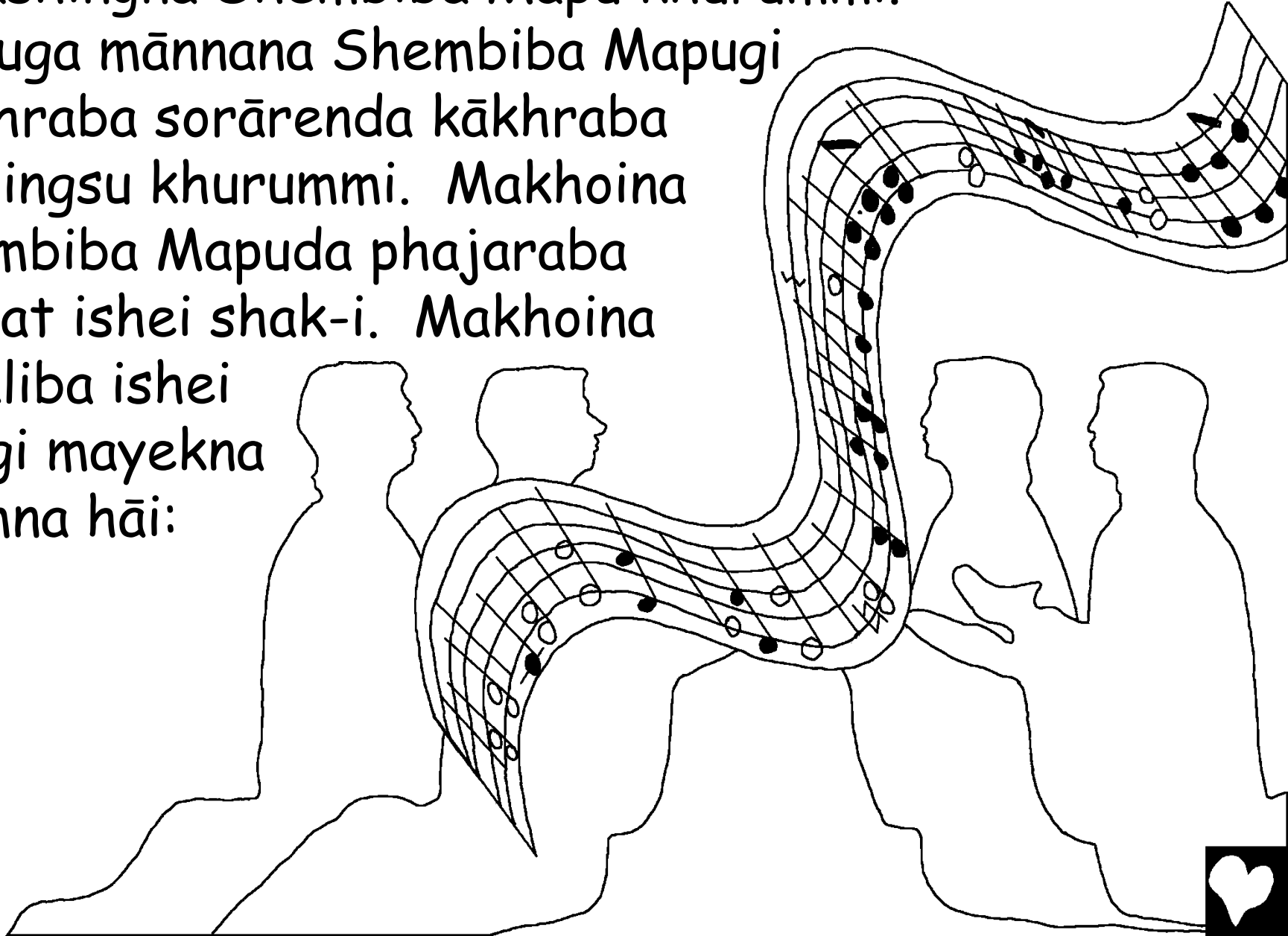

NAHĀKTI MATIK CHĀBA SHEMBIBA MAPUNI,
PHURUP AMASUNG LEIBAK KHUDINGDAGI
EIKHOIBU NAHĀKKI MAMAL
YĀMLABA I ADUNA SHEMBIBA
MAPUGI MAPHAMDA
HANDOKPIRE AMASUNG
EIKHOIBU SHEMBIBA MAPUGI
MANGDA
NINGTHOU
AMASUNG
AMĀIBASHING
OIHANBIRE.

(Phong.
5:9)

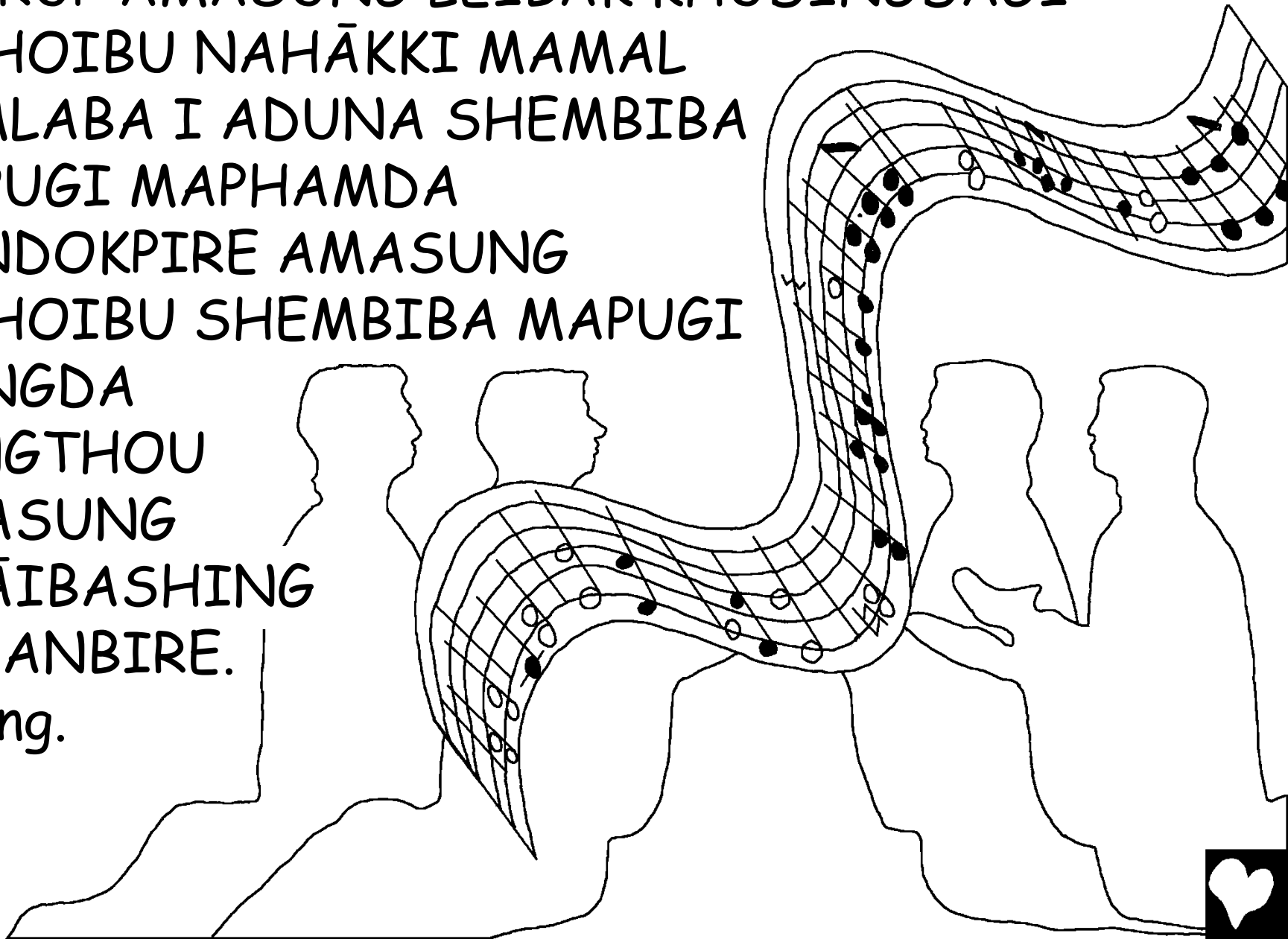

Bible gi aroiba lamāida sorārenbu "anouba Jerusalem"
oina shugāina tāki. Madu yāmna chāo-i, awāngba
chekpalna koishilli. Chekpal adu mamal yāmlaba
tampha ahangba nungna shāi aduga mayek shengna
ui. Chekpalgi leikhongshing adu mamal yāmlaba nung
makhal kayāna leiteng-i,

phajaraba
machuna
meirikkum
irang lang-i.
Achouba khunjāo
adugi thonggāl
khudingmak
mamal yāmlaba
achouba nungna shāi!

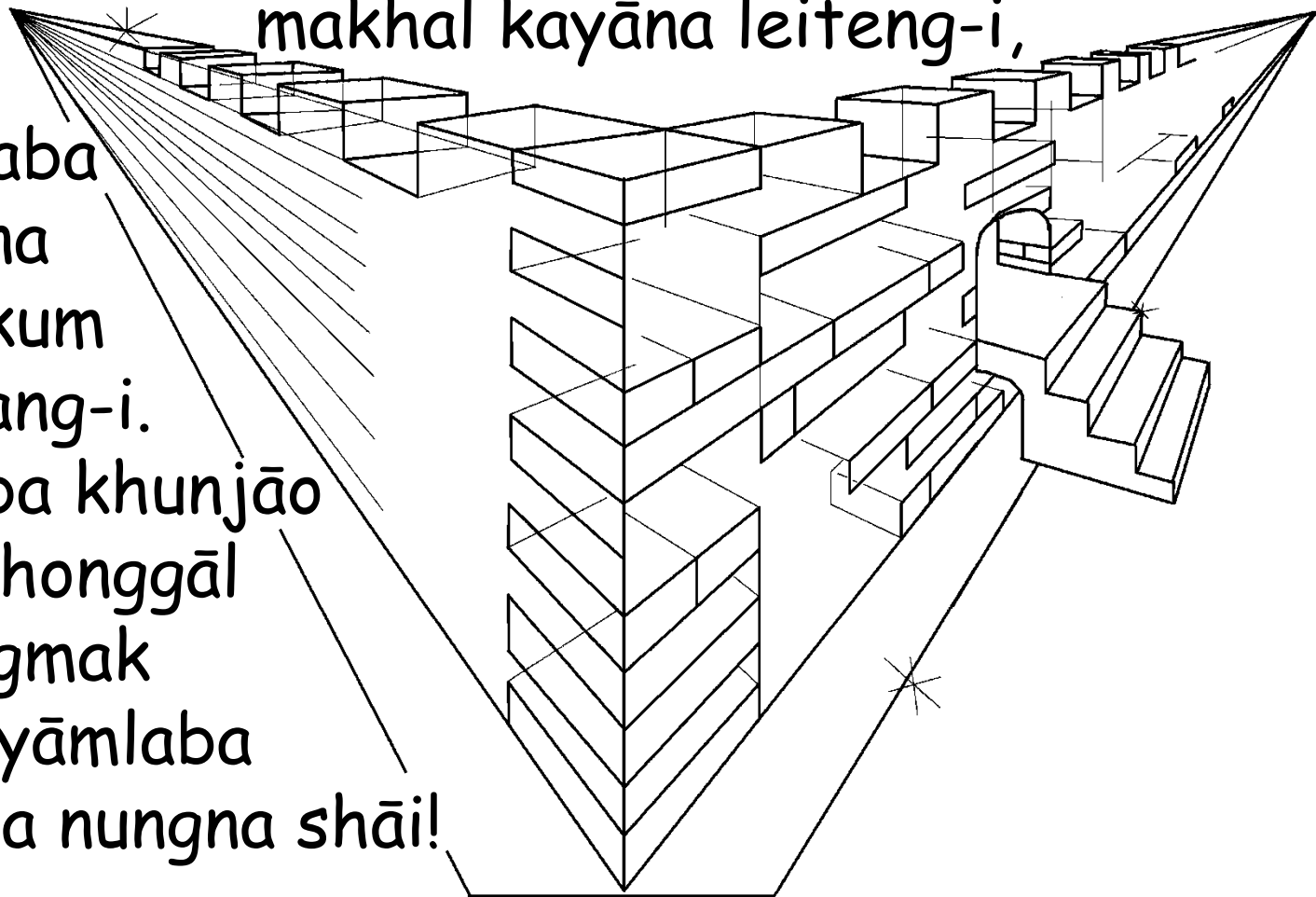

Mamal yāmlaba achouba nungna shāba thonggālshing
adu matam chupda hāngduna lei. Manungda
changduna yengsi ... Wow! Sorāren asidi manungda
henna phajei. Achouba khunjāo asi ashengba sānāna,
arangba mingshelga
mānei. Lambi
phāoba
sānāna
shemlammi.

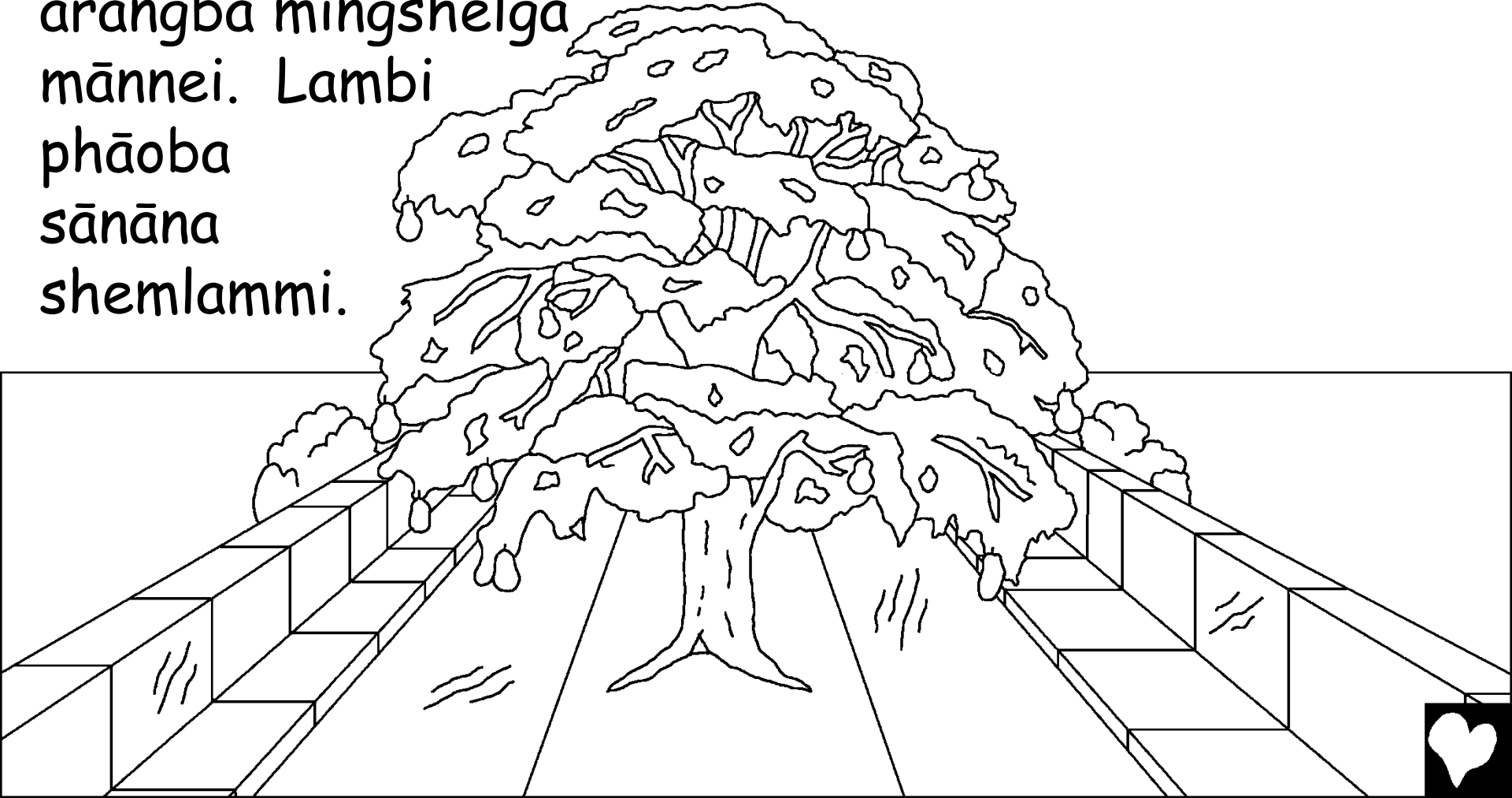

Yāmna phajaraba, aruba hingbagi ishing turel
Shembiba Mapugi phambāldagi chelli. Turel adugi
atoppa nakanda Eden gi leikonda ahānba leiramba
ahingba u-pāmbi hou-i. U-pāmbi asi yāmna maru oi.
Masida tha khudinggi tongān-tongānba uhei pālli.
Amasung ahingba u-pāmbi asigi manana leibākshinggi
anāba phahalli.

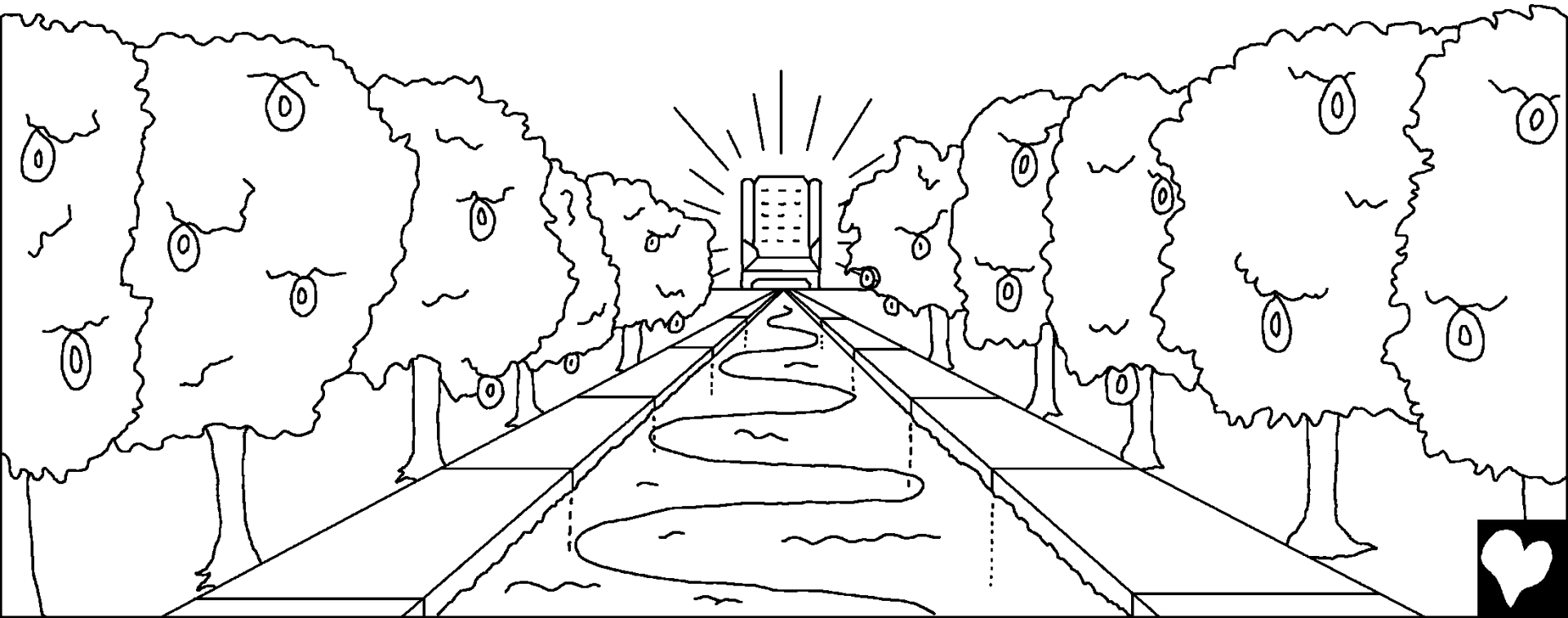

Sorārenda numit nattraga thāgi mangāl mathou
tāde. Shembiba Mapugi angakpa matik mangālna
ngānduna lei. Mapham aduda ahing hāiba leite.

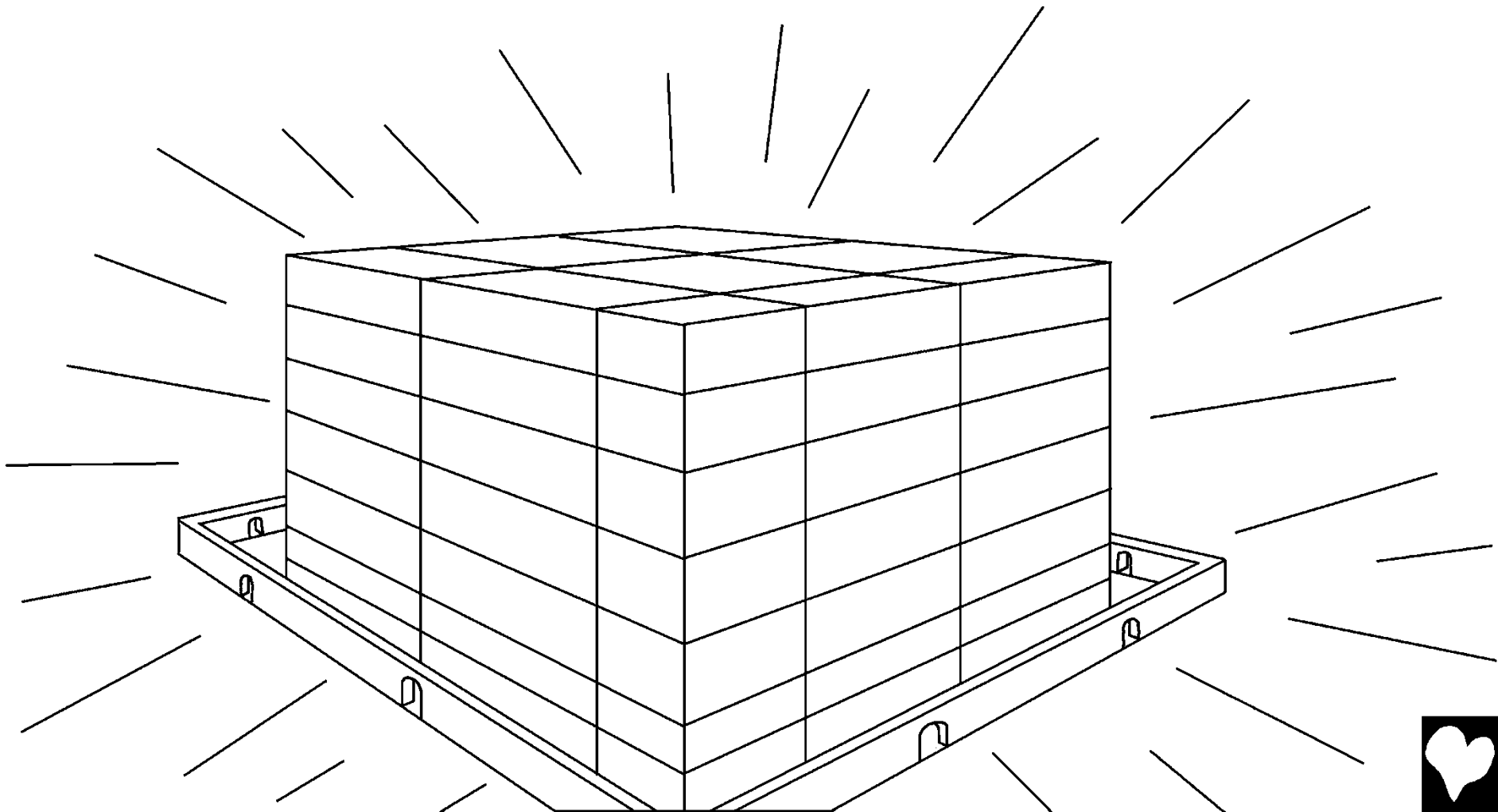

Sorārenda sha-shan phāoba tongalli. Makhoi
mabuk tappi amasung tinnaba yāi. Keishāl amasung
yāoshing punna chāktāminnei. Mapānggal kallaba
nongsha phāoba shannāo machāgum charu chāi.
Ipuroina hāi, "eigi ashengba chingjāo mathakta
makhoi ashok-apan leiroi natraga mang-tāk-hanba
ngamloi".



Eikhoina koina yengbada, sorārenda leitaba potshing
eikhoina uba ngammi. Ashāoba wa tāba phangde.
Khatna-cheinaba amata leite natraga mashāgi
oijaba thiba
leite. Thong
sho pānde,
maramdi
sorārenda
hurānba
leite.



Machin thiba mi leite, mihātpa, potshem shānaba,
natraga phattaba mi amata leite. Sorārenda
ayon-arān makhal
amata leite.

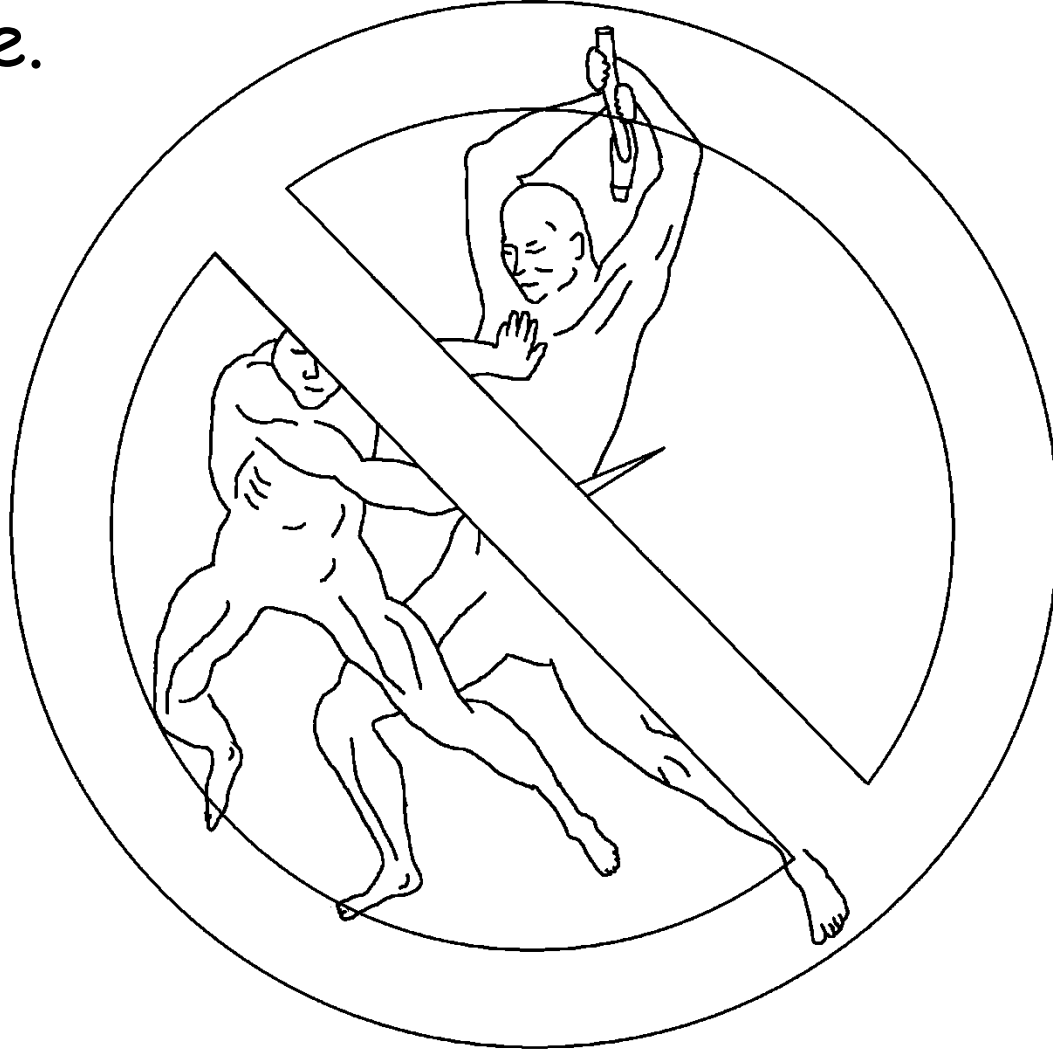



Sorārenda Shembiba
Mapuga loinana leiba
matamda mittagi pi
tāba leiraroi.

Karigumba matamda,
tāibangpānbagi
awābana maram
oiduna Shembiba
Mapugi mishing kappi.
Sorārenda, Shembiba
Mapuna eikhoigi mitki
pi teithokpigani.



Sorārenda shiba nāide. Shembiba Mapugi mishing
Ipuroiga loinana matam chuppa leiminnagani. Awāba,
mikap-mirāokhon, hakachāng naba amata leiroi.
Hakachāng nabagi awāba, khāinaba, shibagi potloiba
amata leiroi. Mi

khudingmak
sorārenda
Shembiba
Mapuga
loinana
matam
pumnamakta
nungngāina
lei.



Khwāidagi phaba, sorāren asi Jishu Khrista
bu kanbiba mapu ama oina thājaba amasung
mahākki hāiba inba nipāmachāshing amasung
nupimachāshingini (ahal oiraba mishinggisuni).

Sorārenda yāo machāgi hingbagi lāirik
hāina kouba lāirik ama lei. Masida migi
maming pik thanna iduna lei.

Maduda kanagi ming
iduna lei hāiba nang
khangbra? Jishu da
thājaba thamba mi
pumnamakki mamingni.
Nahākki naming
maduda yāorabra?



Sorāren-gi maramda Bible gi aroiba
wāheida angakpa pāokat ama piri. "Thawāi ashengba
amasung luhongbagi pibāren aduna hāi, 'lāk-u!' masi
hāiba tāba mina hāisanu 'lāk-u'! Aduga khourangba mi
aduna lāksanu. Amasung apāmba leiba mi khudingna,

lāktuna
hingbagi
ishing

adu
mamal
pidana
loujasanu."



Shembiba Mapugi Ningthijaraba Yum, Sorāren

Shembiba Mapugi wāhei, Bible da yāoba wāri

Asida phang-i

John 14; 2 Corinthians 5;
Phongdokpiba 4, 21, 22

“Nahākki wāhei changlakpada mangāl phang-i.”
Ishei Lāirik 119:130



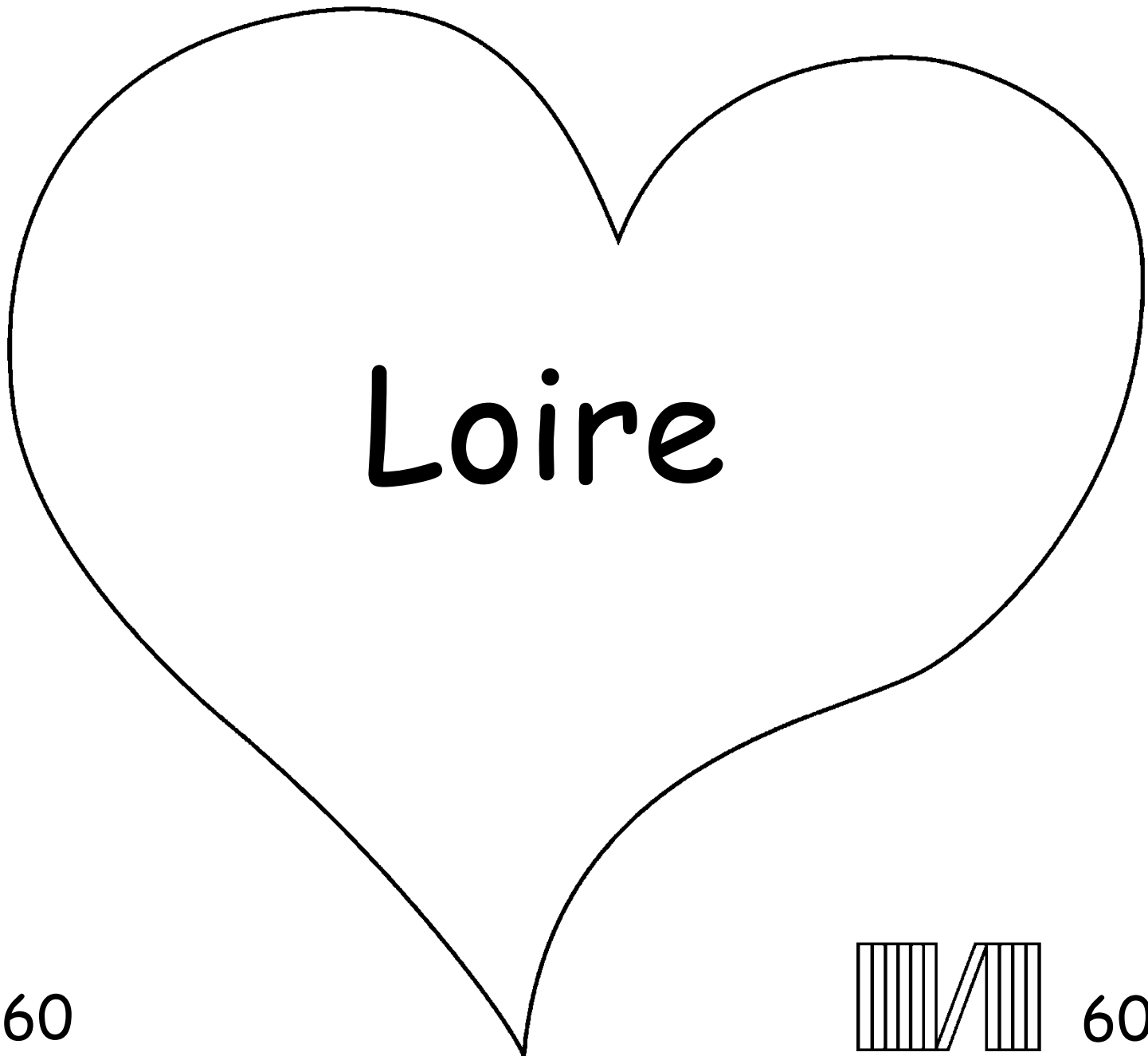

Loire

60

60



Bible gi wāri asina matik-mangālna thallaba eikhoigi Shembiba Mapugi maramda amasung Ibungngo mahākpu eikhoina mashak khangba mahākna pām̄mi hāibagi maramda eikhoida tākpi.

Shembiba Mapuna ayon-arān hāina kouba phattaba thabakshing eikhoina toure hāiba Ibungngo mahākna khang-i. Ayon-arān-gi atoumaldi shibani, adubu Shembiba Mapuna nahākpu asukki matik nungshibi maram aduna mahākki amata ngāiraba machānipa Jishu bu nahākki ayon-arān-gi ushin oina u-kārong mathakta shibinaba thābire| aduga Jishu na amuk shibadagi hinghattuna sorārenda kākhi! Nahākna Jishu bu thājarabadi amasung nahākki

ayon-arānshingdu kokpiyu hāina mangonda hāijarabadi, mahākna shoidana kokpigani! Mahāk nangi punsida lākkani amasung mahākka loinana lomba nāidana hingminnaba phangani.

Nangna masi achumbani hāina thājarabadi, asumna Shembiba Mapuda hāijou: nungshiraba Jishu, ei nahākpu Shembiba Mapuni hāiba thājei, nahākna tāibangpānda mi oina lāktuna eigi ayon-arān-gi damak shibi amasung shibadagi hinggakhi. Eigi punsida lākpiyu aduga eigi ayon-arānshing ngākpiyu, aduga ei anouba punsi houjik phangjage amasung nahākka loinana lomba nāidana hingba phangjage. Nahākki hāiba inba nacha ama oina hingba ngamnaba eigi iteng pāngbiyu. Amen.

Numit khudinggi Bible pāo amasung Shembiba Mapuda hāijou! John 3:16

