

Al-Kitab untu' Ana'-ana' Memperssembahkan

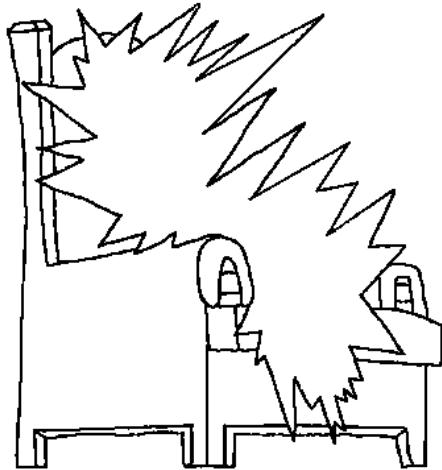

Suruga, Bolana Allataala iya makessingngé



Parokina Iyanaritu: Edward Hughes
Pa'gambarana iyanaritu: Lazarus
Pengadaptasinna iyanaritu: Sarah S.
Penterjemana iyanaritu: Armin Sukri
Paproduksina iyanaritu: Bible for Children
www.M1914.org

BFC
PO Box 3
Winnipeg, MB R3C 2G1
Canada

©2011 Bible for Children, Inc.

Ijin: Weedimmua rilemba iyaré curitaé iyakiya de' nawedding ri balu'.

Riwettunna Isa tuwo ri linoé napowadai lao ri
ana'-ana' gurunNa passalengna suruga. Aléna naseng
"Bolana Ambo'ku," makkedai maéga bola kuwaro.

Bola iya maloppoé natemmaka
makessinna. Suruga
iyanaritu onrong iya
temmaka kessinna
na onrong laingngé
iya engkaé ri
suruga.

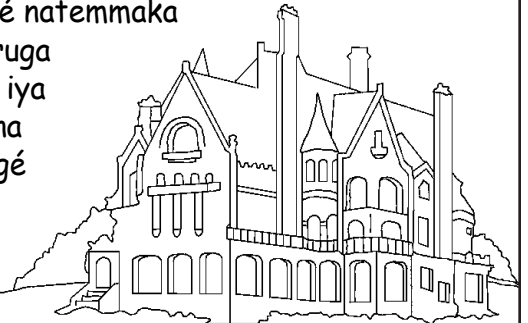

Makkeda Isa, "Maéloka lao passadiangekko onrong. Narilaoku passadia onrong, maéloka lisu paimeng untu' tarimako." Isa Al-Masih lisu paimeng ri suruga purana tuwo paimeng. Wettuna naita ana'-ana' gurunNa, menré'ni Isa risalémuri ellung gangkana lennye' polé ripakkitanna mennang.

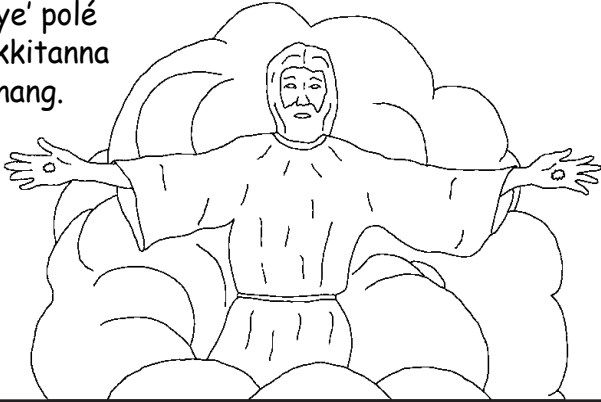

3

Mappammula kuwaro, sininna umma' Kristen maréngngerangngi makkeda Isa maéloi lisu paimeng untu' tiwi manengngi ri onronNa. Isa makkeda maéloi lisu matti. Iyakiya pekkugiwi rékko matéki ridénapa nalisu Isa? Kitta'é napoadai makkeda, laoi mennang sibawa Isa. Maté sicara jasmani iyakiya tuwoi



sibawa Puangngé.

4

Wahyu, kitta' paccappureng rilaleng Al-kitab, powadangngi temmaka kessinna onrong riasengngé suruga. Passaleng iya kaminang makessingngé iyanaritu suruga bolaNa Allataala. Allataala engkai kega-kega muwa, iyakiya onronNa iyanaritu ri suruga.

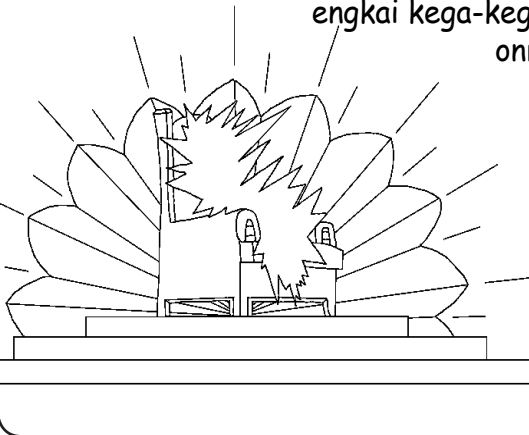

5

Malaika' sibawa séuwaé ri suruga nasompawi Puang Allataala ri suruga. Sininna tau matepe'é iya matéwé lao ri suruga. Makkélongngi pojiwi Allataala.

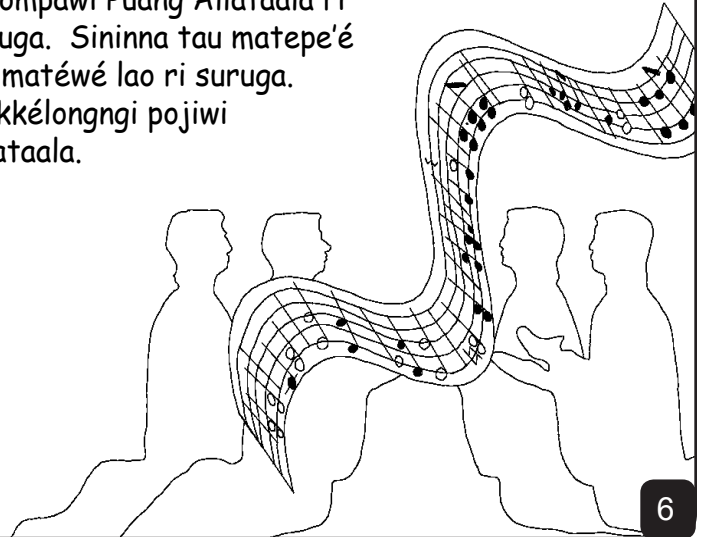

6

Kuwaré engka ada-ada polé ri élonna: **MAPACCIKKI' PUANG NASABA' ALETA PURAKI' MUPALEPPE' POLE RIDOSAE NAOLAI DARAMU RISININNA SUKU, BANGSAE, SIBAWA MUPANCAJIKI' RAJA SIBAWA IMANG LAO RI IDI' PUANG.** (Wahyu 5:9)

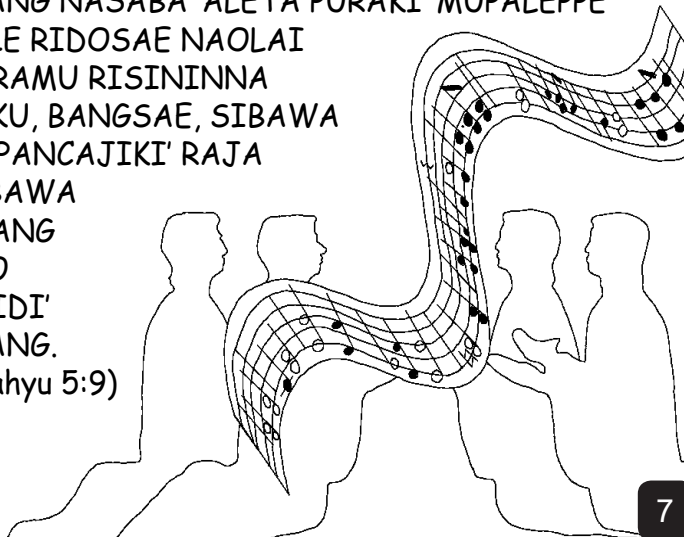

7

Ripaccappurena kitta'é suruga riasengtoi "Yerusalem baru". Temmaka loppone nakelilingi sappo loppo saliwenna. Sappo batu Jasper, mapaccing pada-pada Kristal.

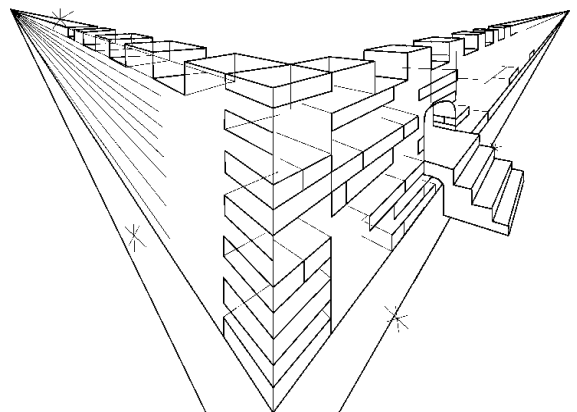

8

Permata sibawa batu-batu berharga mancajiwi pondasi iyaro sappoé, mattappa makkarupa-rupang. Tungke'-tungke' tange' gerbanna riabbu polé ri mutiara loppo.

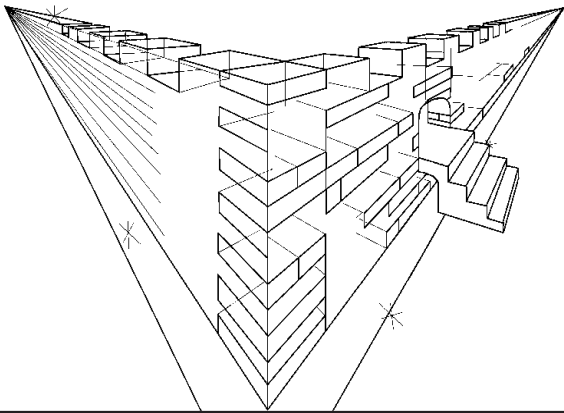

9

Iyaro tange' gerbanggé de' naengka natassampo. Tama'ni makkita-kita...WOW! Temmaka kessinna surugaé. Iyaro kotaé riyabbui polé ulaweng pada-pada kaca, tattanaéto riyabbu polé ulaweng.

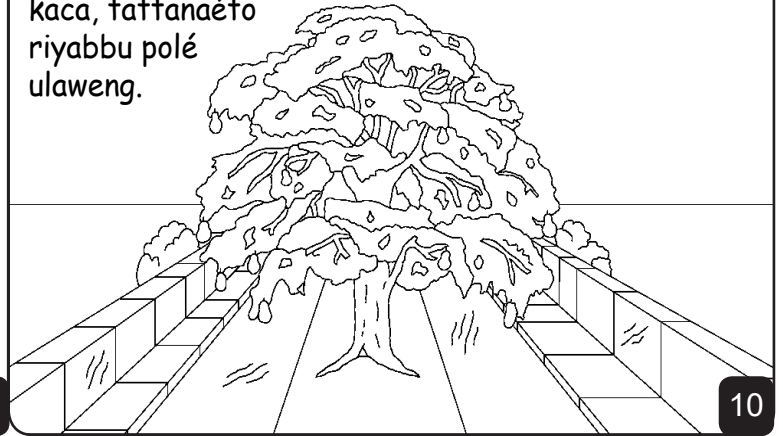

10

Temmaka kessinna, salo mapaccing massolo' polé ri tudangenna Allataala. Engkato pong aju atuwong, iya engkaé ri dare' Eden ri pammula-mulanna. Iyaré pon ajué temmaka kessinna. Engka seppuladuwa rupanna buwa ri batanna, laing tungke'-tungke' uleng. Dau'-daunna iyanaritu pajjappana bangsa-bangsaé.

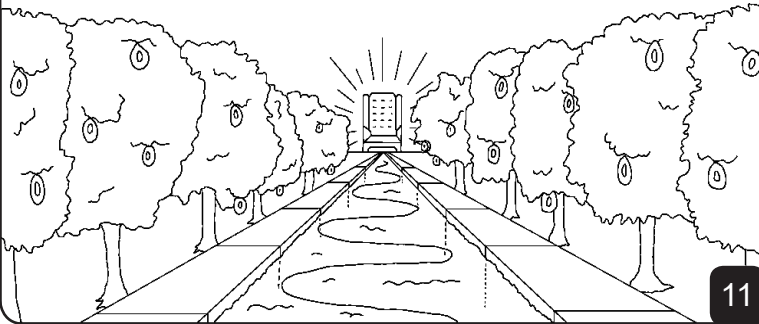

11

De'naparellu mataesso iyaréga kéteng ri suruga. Nasaba' kemuliaanNa Allataala cakkariwi. De'gaga wenni rionrongéro.

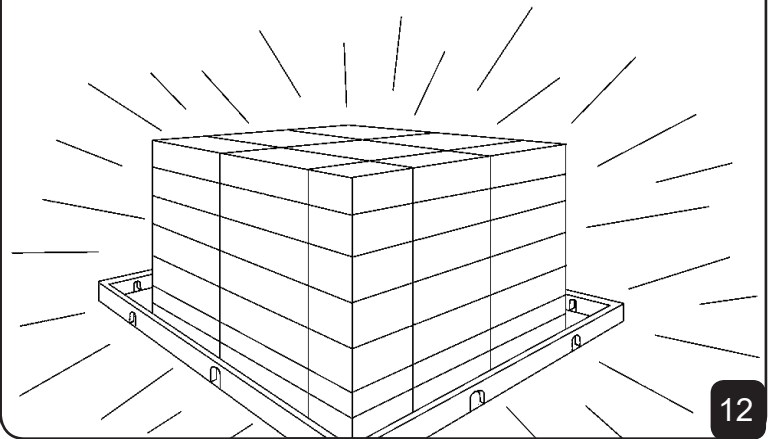

12

Olo-kolo' ri surugaé laing muto rupanna. Dé'gaga olo-kolo' maliya'. Asu ale' sibawa bémbala' manré wella massibawa. Namuni singaé manrétoi wella pada-pada sapingngé. Makkeda Puangngé, "Dé'gaga macilaka iyaréga mapeddi ri bulu' mapaccing-Ku."



13

Narékkko makkitaki' risekelilitta, engka séddi de'gaga riruntu' ri Suruga. De'gaga ada-ada maja'riyangkalinga.

De'gaga tau mallaga atau simmusu'.

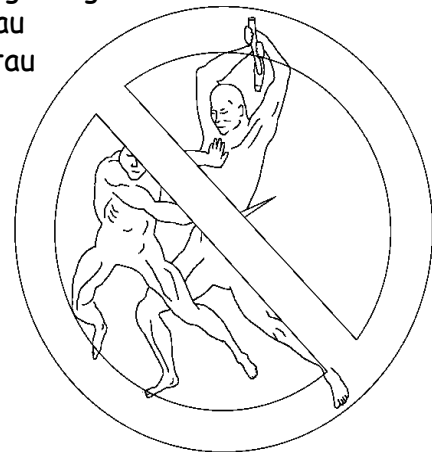

14

De'gaga goncing ri tange'é, nasaba' de'gaga panga ri suruga. De'gaga pa'bellé-bellé, pauno, sanro sehére, iyaréga tau maja sipa'. De'gaga dosa turunan ri suruga.

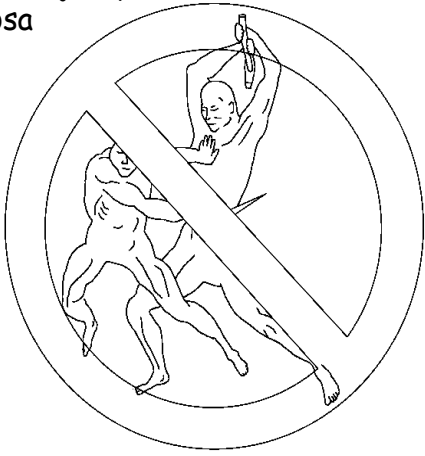

15

Dé'gaga uwai mata ri suruga. Biasa tau mateppe'é kara'i nasaba' anrasa-rasanna rilaleng atuwonna. Ri suruga, Allataala nasapu manenggi uwai mataé.



16

Dé'gaga amaténg risuruga. Tau mateppe'é engkai tuwo mannengeng ri suruga. De'gaga pessé na anrasa-rasang, de'gaga terri, de'gaga peddi. De'gaga lasa, pesta, iyaréga attampungeng. Sininna engkaé ri suruga masennang manenggi sibawa Allataala.



17

Iya madécénggé, suruga untu' worowané sibawa makkunrai iya mateppe'é lao ri Isa Almasih sélaku pappasalama'na sibawa naturusiwi sélaku Puang. Ri suruga engka séddi bo'bo' riyaseng Bo' Atuwong. Engka maéga aseng rilalenna. Muwissengngiga niga aseng riyoki' rilalenna? Sininna tau iya mateppe'é lao ri Isa. Engkaniga asemmu kuwaro?

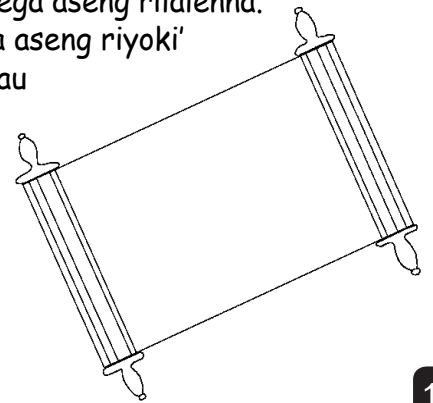

18

Ripaccappurena kitta'é passalenna suruga engka ada-ada iya kaminang makessingngé lao mobbi'ki'. "Makkedani Roh Mapaccingnge sibawa bottingngé, 'Laoni maé!' Lappessani sininna maréngkalingaé makkeda 'laoni Maé!'

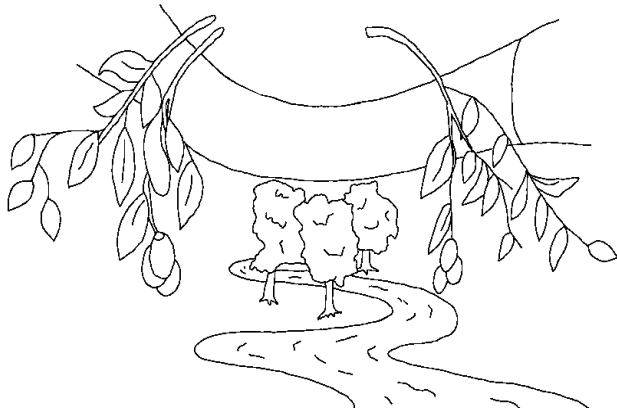

19

Lappessani tau madekkaé maddeppé. Sininna tau parellué, lappessani tarima uwai atuwong sicara cuma-cuma."



20

Suruga, Bolana Allataala iya makessingné

Seddi curita polé riada-adanna Puang
Allataala, Al Kitab,

niruntu' rilaleng

Yohanes 14, 2 Korintus 5,
Wahyu 4, 21, 22

"Rekko ripakanessai, ma'bbéréi tajang
pappaguruwam-Mu." Mazmur 119:130

21

60



60

22

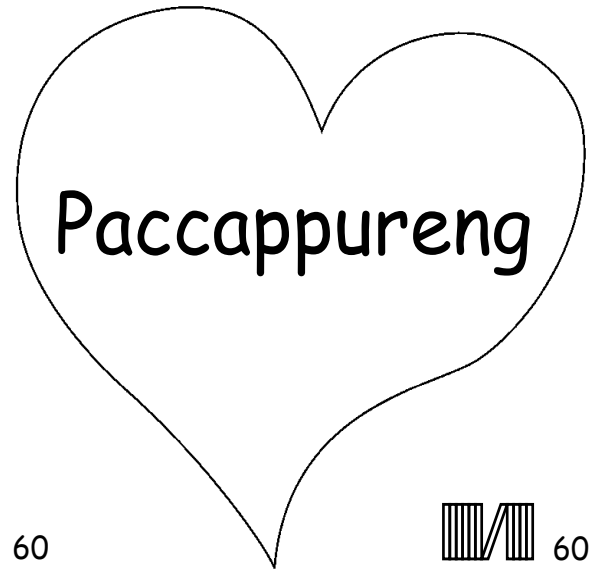

Paccappureng

Iyaré curita pole ri Al-Kitab powadai passalenna Puang kaminang
malebbié iya puraé pancajiki,' naiya maélo' toi kuammengngi idi' misseng
toi Aléna.

Puangngé naissengngi makkeda purai ri pogau maja'é, iya riasengngé
dosa. Pahukkungenna dosaé iyanaritu amateng, iyakiya Puangngé
makkumani namaséi ki' na nabbéréangngi Ana' tungke'na, Isa, untu' maté
ri aju sall'é sibawa tarimai pahukkungenna dosaé. Isa réwe'I ri
atuwongngé sibawa lisui ri bola ri Suruga! Narékko mateppe'ki lao ri Isa
na marellau ki' addampengeng lao ri dosata, maéloi pogau'I! MaéloI
muttama sibawa monro ri laleng atuwommu, sibawa maéloI tuwo
sibawaki' manennungeng.

Narékkko mateppe'ki' makkedaé tongengngi iya ada-adaé, powadai
makkuwa lao ri Puangngé:

O Isa, mateppe'ka makkeda Idi' natu Puang, purani' mancaji tau lino
enrengngé maté ri dosa-dosa ku, iyakiya makkekkuwangngé tuwoki'
paimeng, Muttamaki' ri laleng atuwokku sibawa addampengengngi
dosa-dosaku, kuwammengngi weddingngi ku tarimai atuwong mabarué,
sibawa engka wettu kuwammengngi weddikka' sibawa ki' mannennungeng.
Tulungka' maccowé ri Idi' sibawa tuwo pada-pada ana'ta. Amin.

Bacai kitta'é sibawa abbicaraki' lao ri Puangngé esso-esso! Yohanes 3:16

