

Al-Kitab untu' Ana'-ana'
Mempersembahkan

Suruga, Bolana
Allataala iya
makessingngé

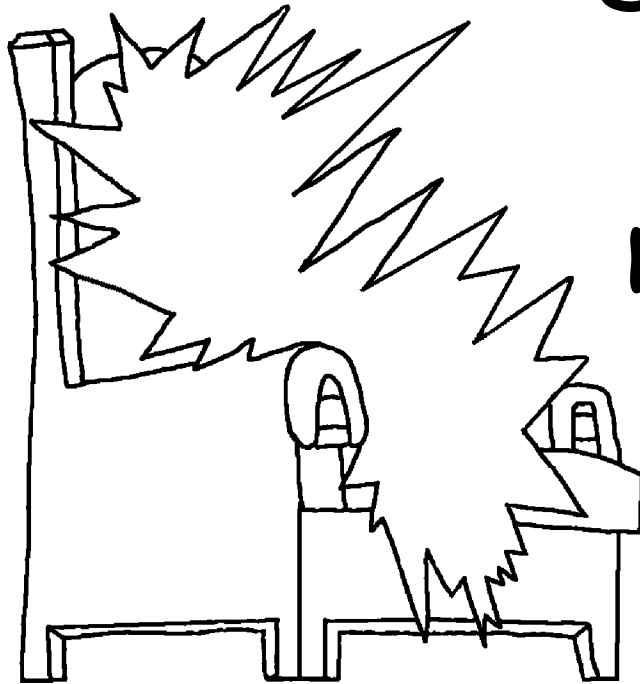

Parokina Iyanaritu: Edward Hughes
Pa'gambarana iyanaritu: Lazarus
Alastair Paterson
Pengadaptasinna iyanaritu: Sarah S.
Penterjemana iyanaritu: Armin Sukri
Paproduksina iyanaritu: Bible for Children
www.M1914.org

BFC
PO Box 3
Winnipeg, MB R3C 2G1
Canada

©2021 Bible for Children, Inc.

Ijin: Weedimmua rilemba iyaré curitaé iyakiya de' nawedding ri balu'.



Riwettunna Isa tuwo ri linoé napowadai lao ri
ana'-ana' gurunNa passalengna suruga. Aléna naseng
"Bolana Ambo'ku," makkedai maéga bola kuwaro.
Bola iya maloppoé natemmaka
makessinna. Suruga
iyanaritu onrong iya
temmaka kessinna
na onrong laingngé
iya engkaé ri
suruga.

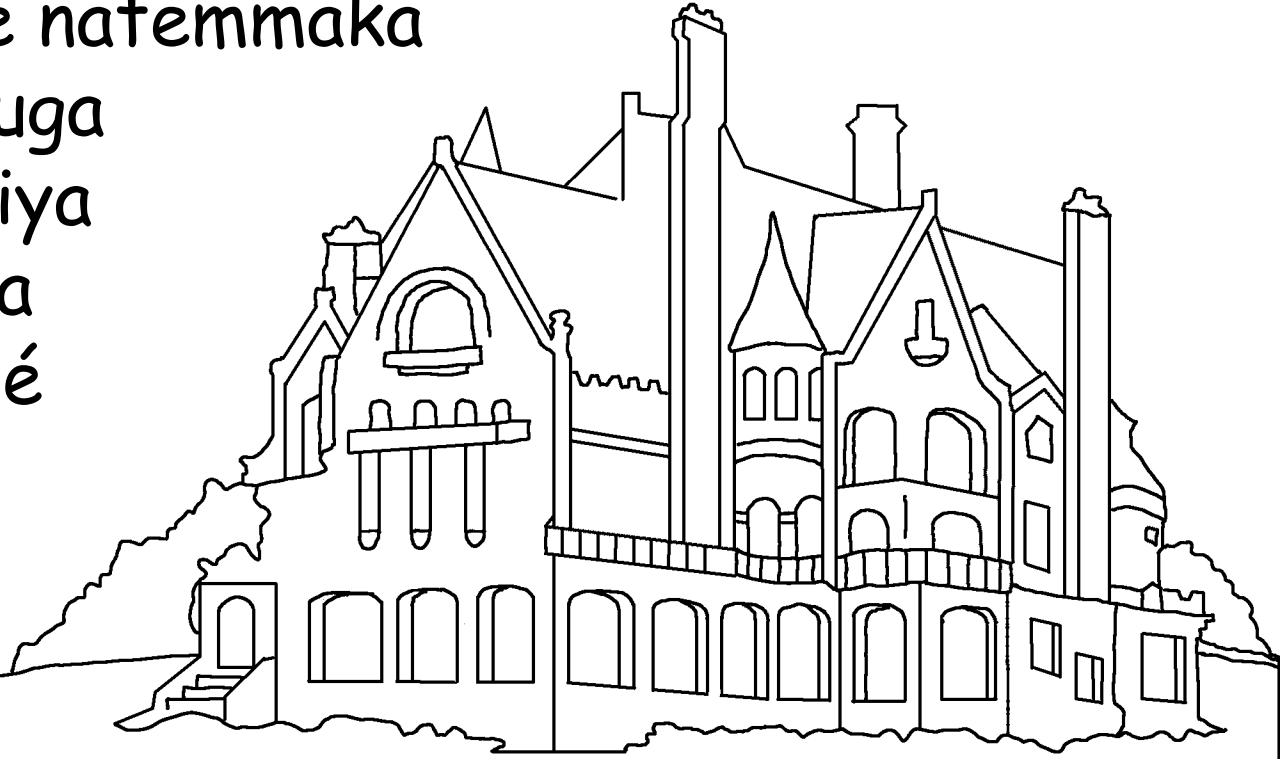

Makkeda Isa, "Maéloka lao passadiangekko onrong. Narilaoku passadia onrong, maéloka lisu paimeng untu' tarimako." Isa Al-Masih lisu paimeng ri suruga purana tuwo paimeng. Wettuna naita ana'-ana' gurunNa, menré'ni Isa risalémuri ellung gangkanna lennye' polé ripakkitanna mennang.

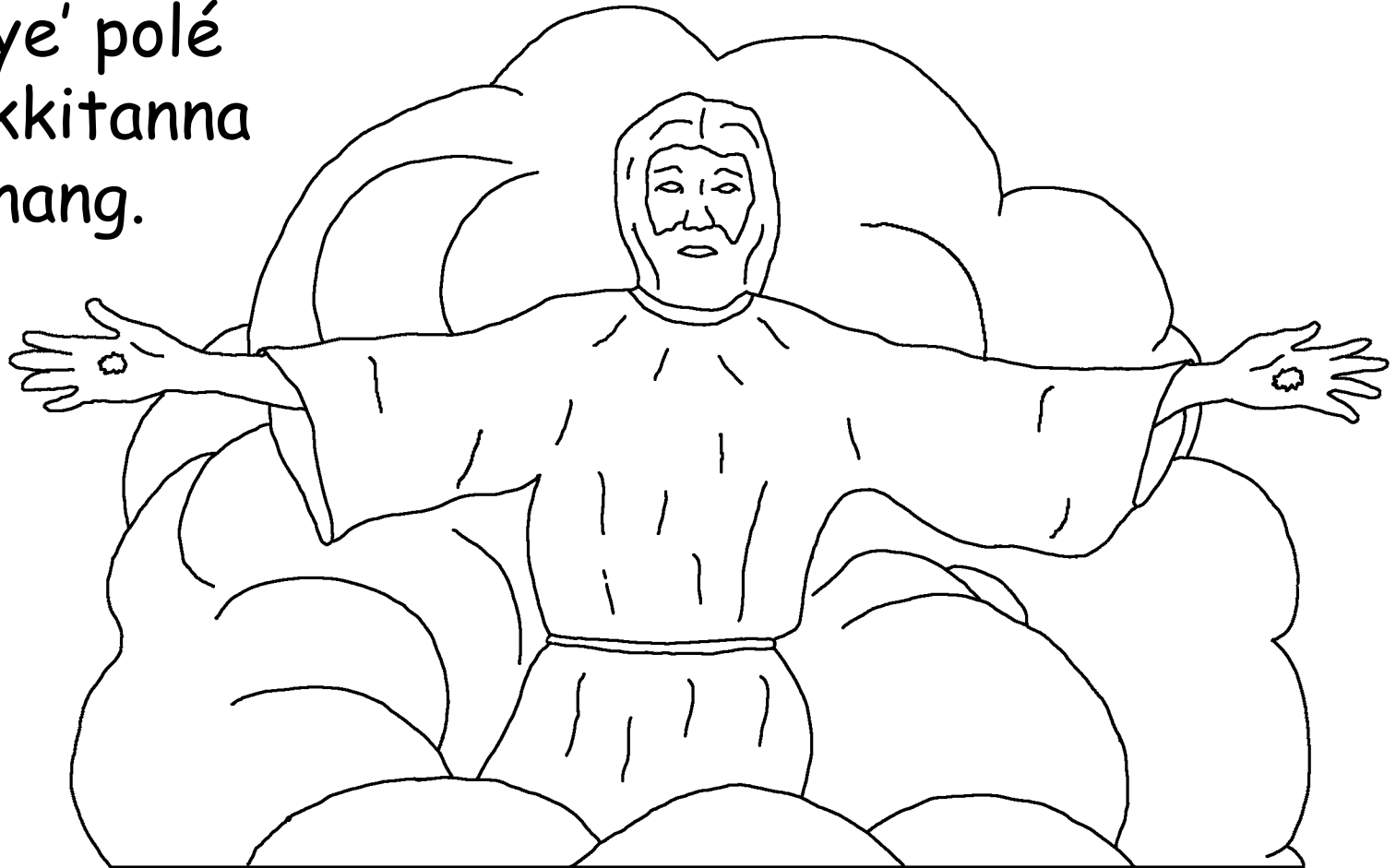

Mappammula kuwaro, sininna umma' Kristen
maréngngerangngi makkeda Isa maéloi lisu
paimeng untu' tiwi manengngi ri onronNa.
Isa makkeda maéloi lisu matti. Iyakiya
pekkugiwi rékko matéki ridénapa
nalisu Isa? Kitta'é napoadai
makkeda, laoi mennang
sibawa Isa. Maté
sicara jasmani
iyakiya tuwoi

sibawa Puangngé.



Wahyu, kitta' paccappureng rilaleng Al-kitab,
powadangngi temmaka kessinna onrong riasengngé
suruga. Passaleng iya kaminang makessingngé
iyanaritu suruga bolaNa Allataala. Allataala
engkai kega-kega muwa, iyakiya
onronNa iyanaritu
ri suruga.



Malaika' sibawa séuwaé ri suruga
nasompawi Puang Allataala ri
suruga. Sininna tau matepe'é
iya matéwé lao ri suruga.
Makkélongngi pojiwi
Allataala.

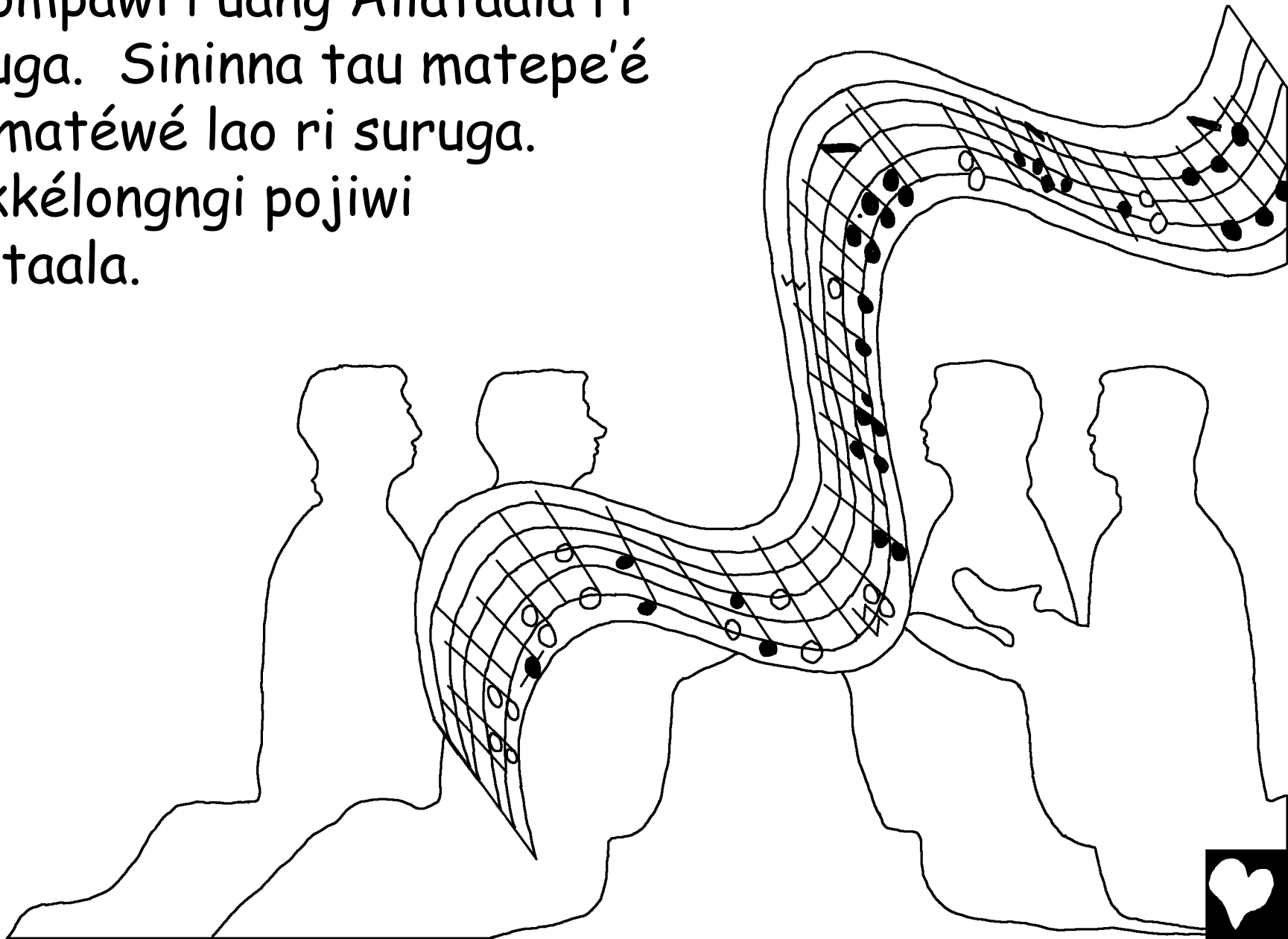

Kuwaré engka ada-ada polé ri élonna: MAPACCIKKI'
PUANG NASABA' ALETA PURAKI' MUPALEPPE'
POLE RIDOSAE NAOLAI
DARAMU RISININNA
SUKU, BANGSAE, SIBAWA
MUPANCAJIKI' RAJA
SIBAWA
IMANG
LAO
RI IDI'
PUANG.
(Wahyu 5:9)

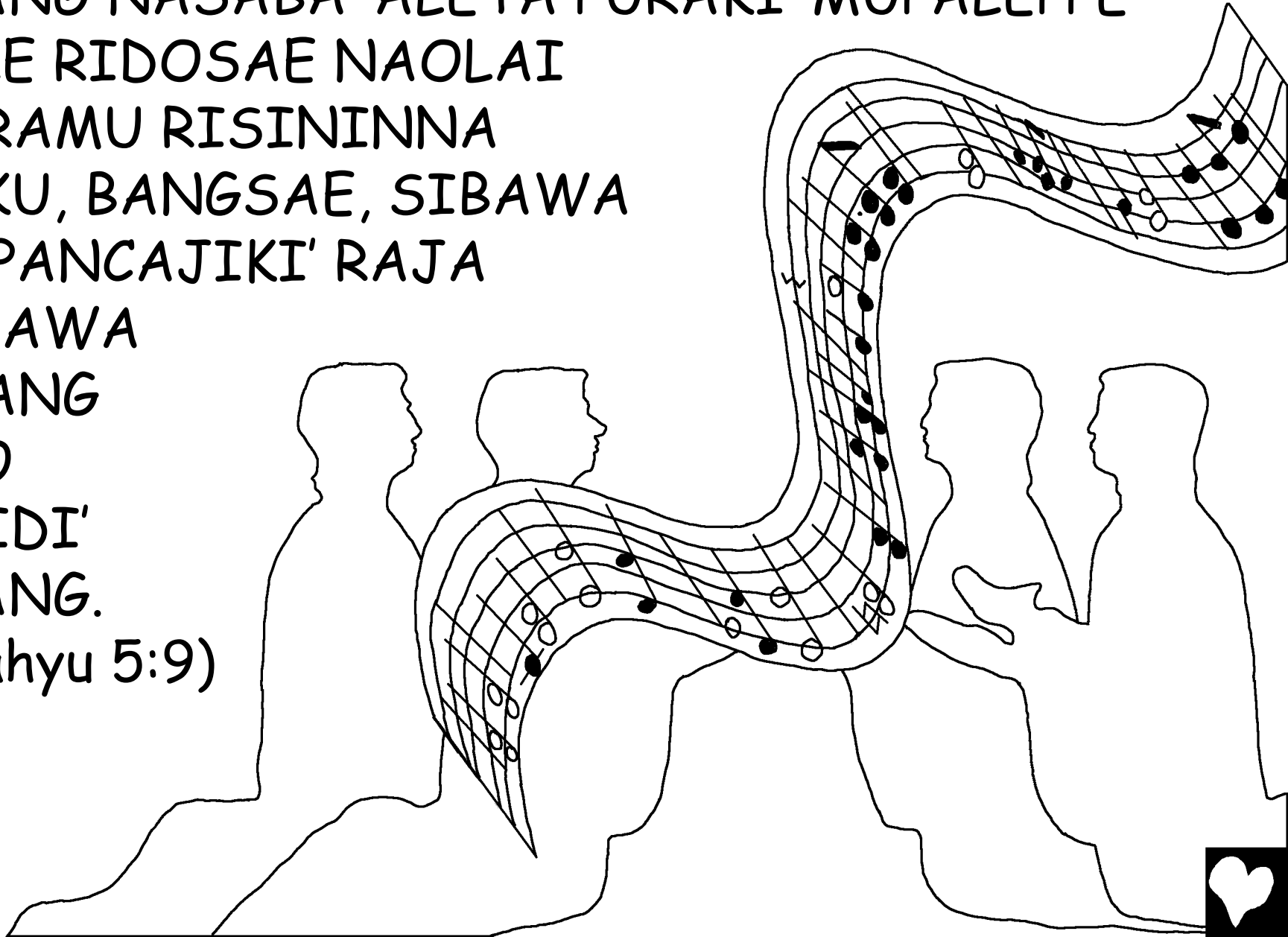

Ripaccappurena kitta'é suruga riasengtoi
"Yerusalem baru". Temmaka loppona nakelilingi
sappo loppo saliwenna. Sappo batu Jasper,
mapaccing pada-pada Kristal.

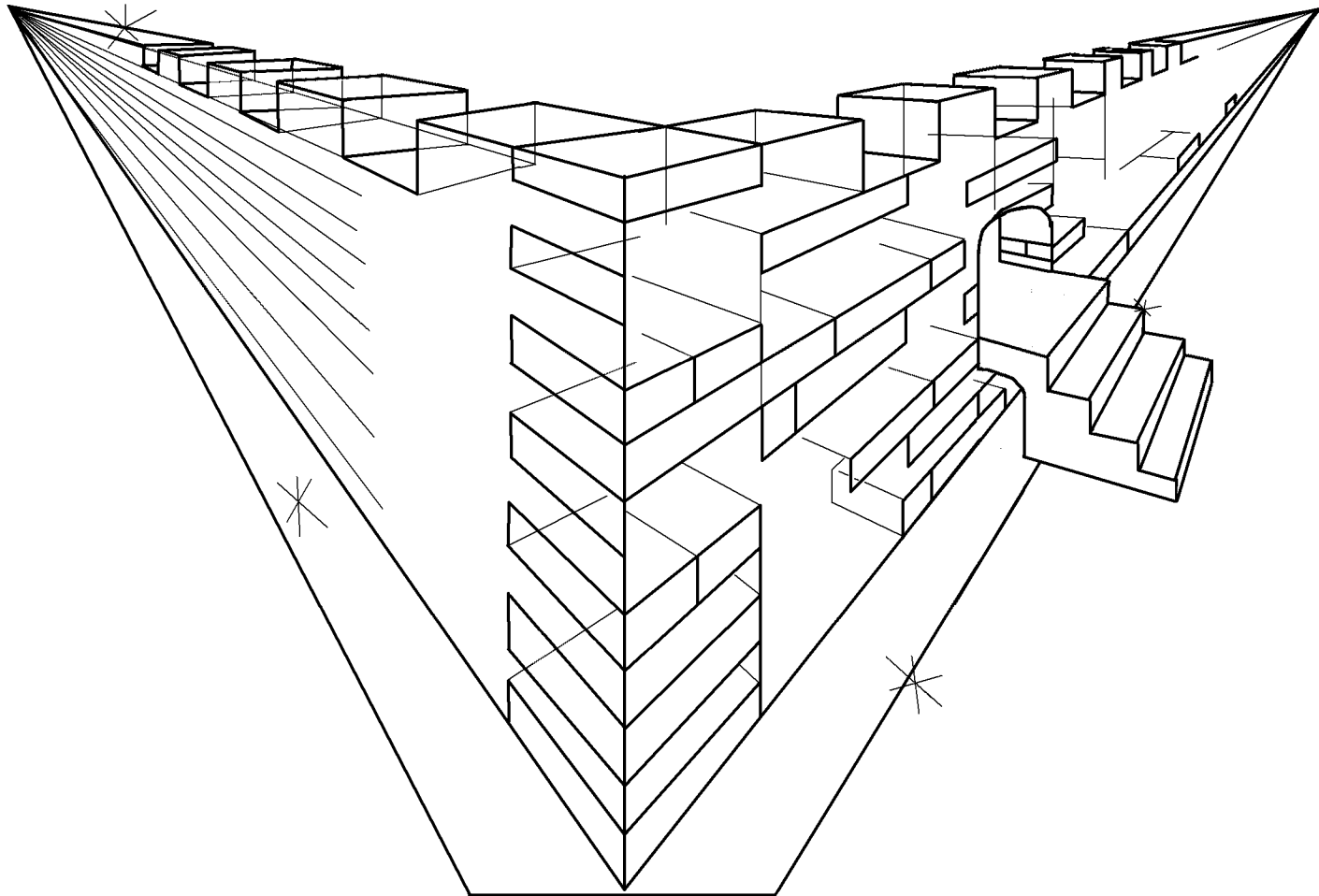

Permata sibawa batu-batu berharga mancajiwi
pondasi iyaro sappoé, mattappa makkarupa-rupang.
Tungke'-tungke' tange' gerbanna riabbu polé ri
mutiara loppo.

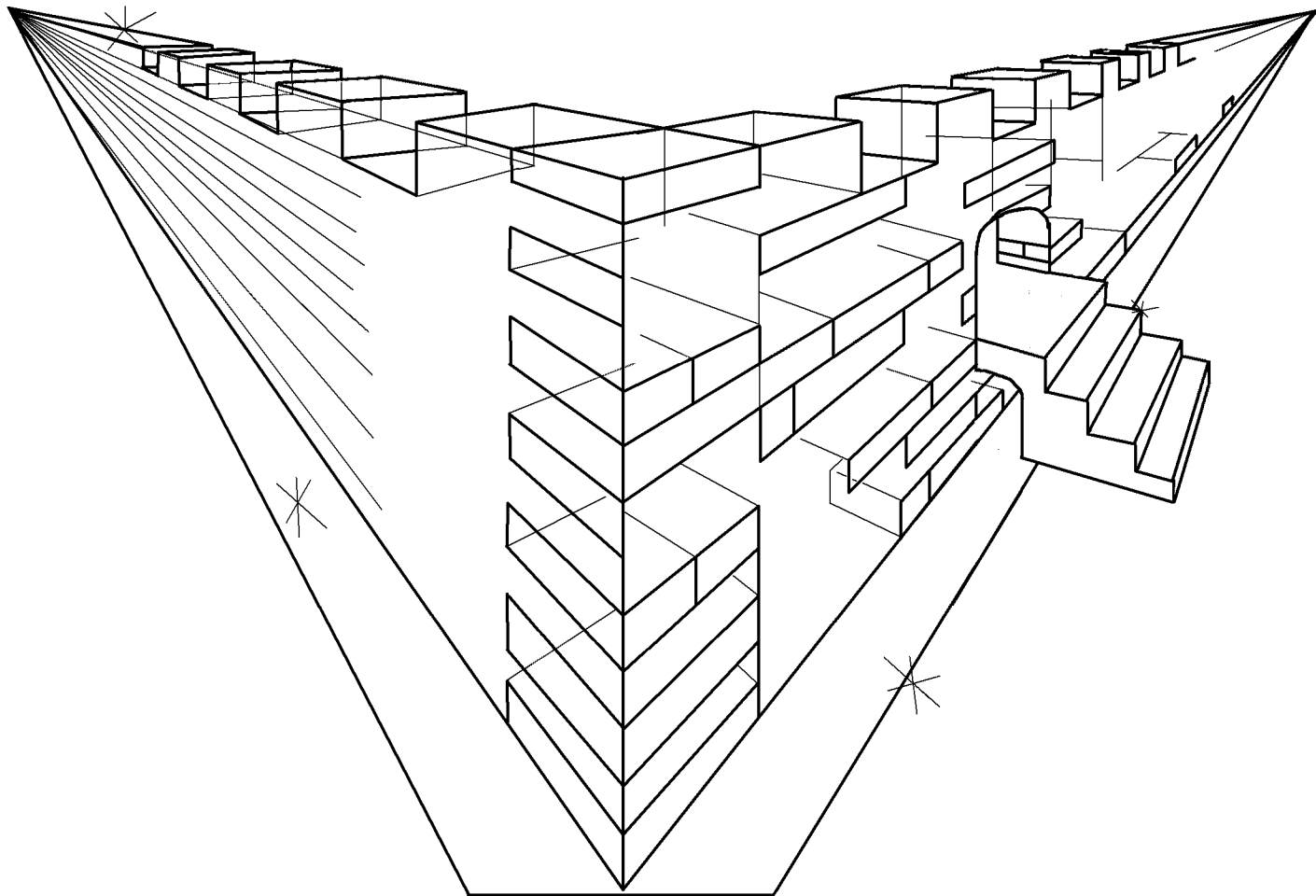

Iyaro tange' gerbangngé de' naengka natassampo.
Tama'ni makkita-kita...WOW! Temmaka kessinna
surugaé. Iyaro kotaé riyabbui polé
ulaweng pada-pada
kaca, tattanaéto
riyabbu polé
ulaweng.

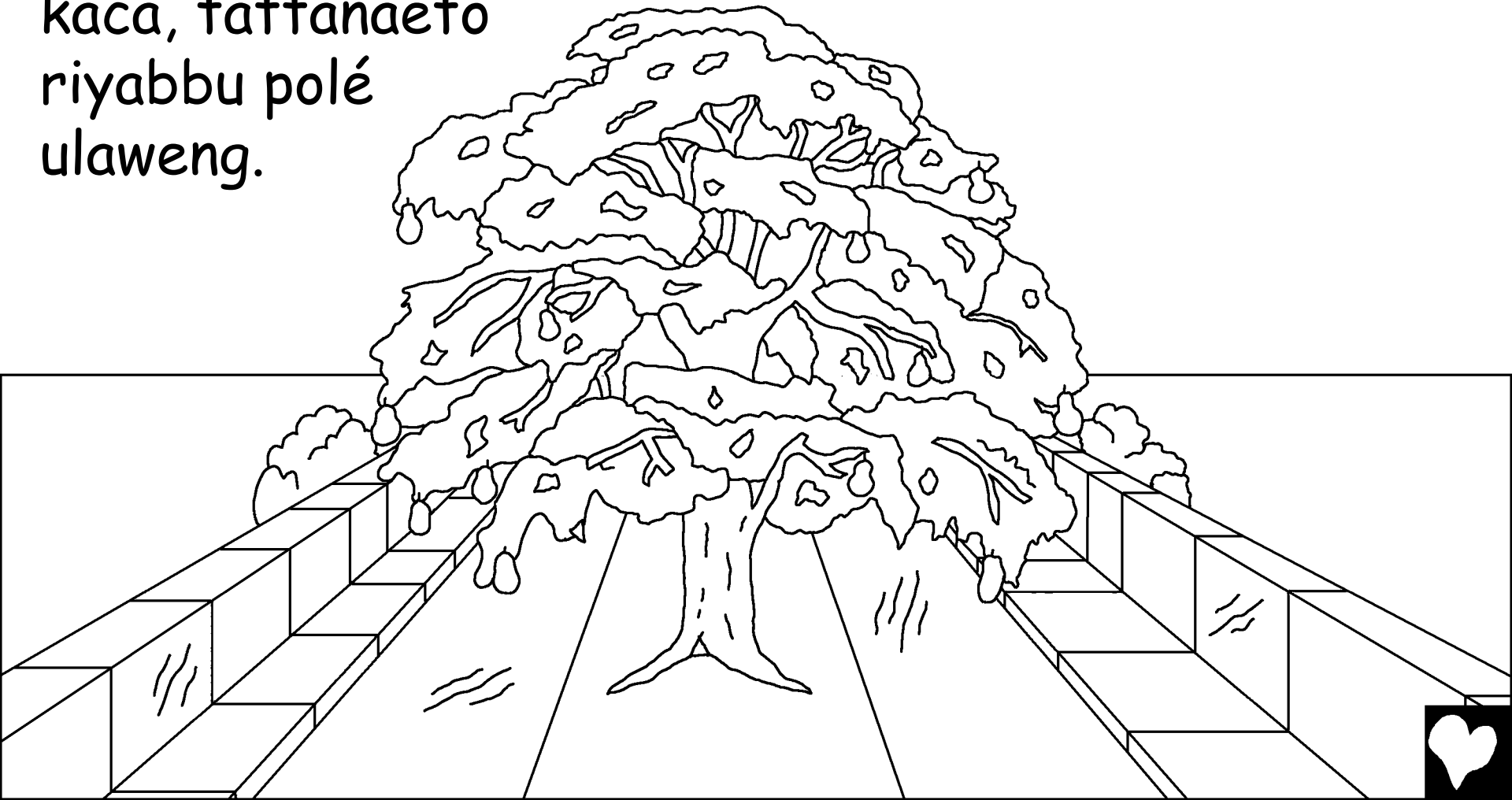

Temmaka kessinna, salo mapaccing massolo' polé ri tudangenna Allataala. Engkato pong aju atuwong, iya engkaé ri dare' Eden ri pammula-mulanna. Iyaré pon ajué temmaka kessinna. Engka seppuladuwa rupanna buwa ri batanna, laing tungke'-tungke' uleng. Dau'-daunna iyanaritu pajjappana bangsa-bangsaé.

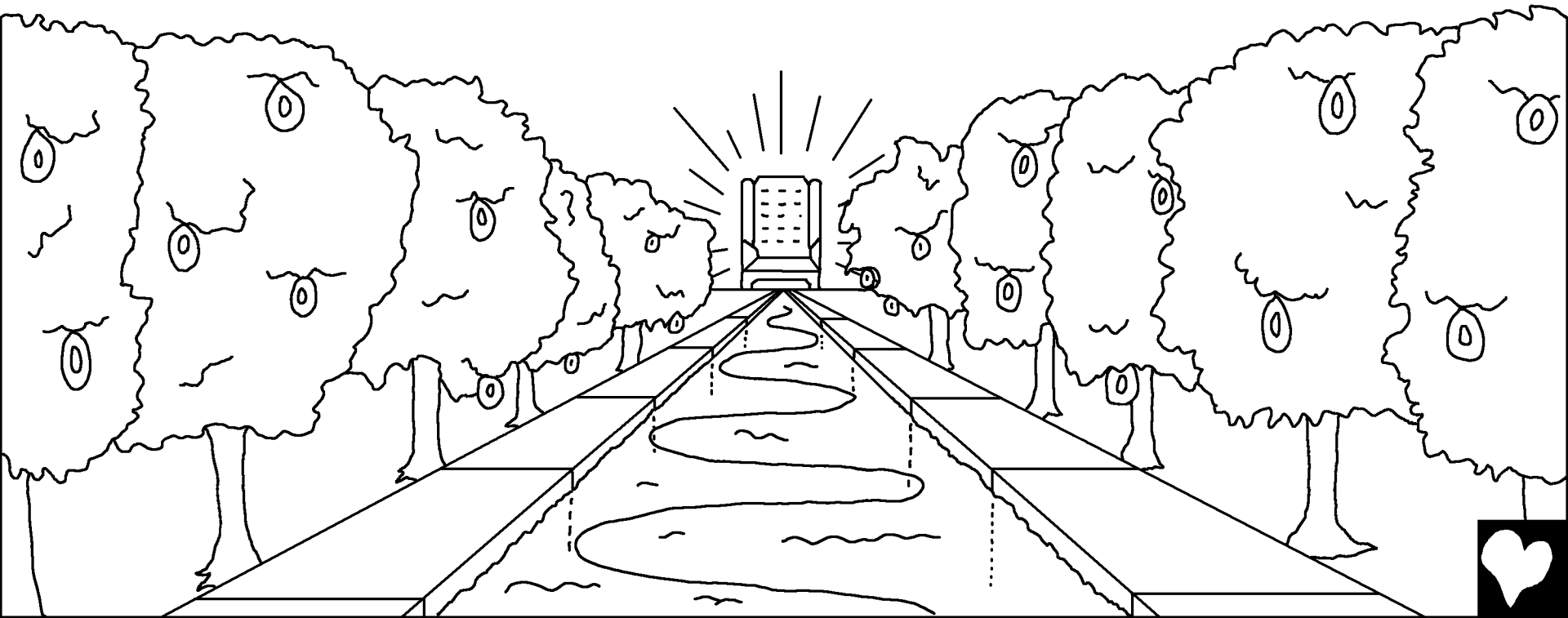

De'naparellu mataesso iyaréga kéténg ri suruga.
Nasaba' kemuliaanNa Allataala cakkariwi. De'gaga
wenni rionrongéro.

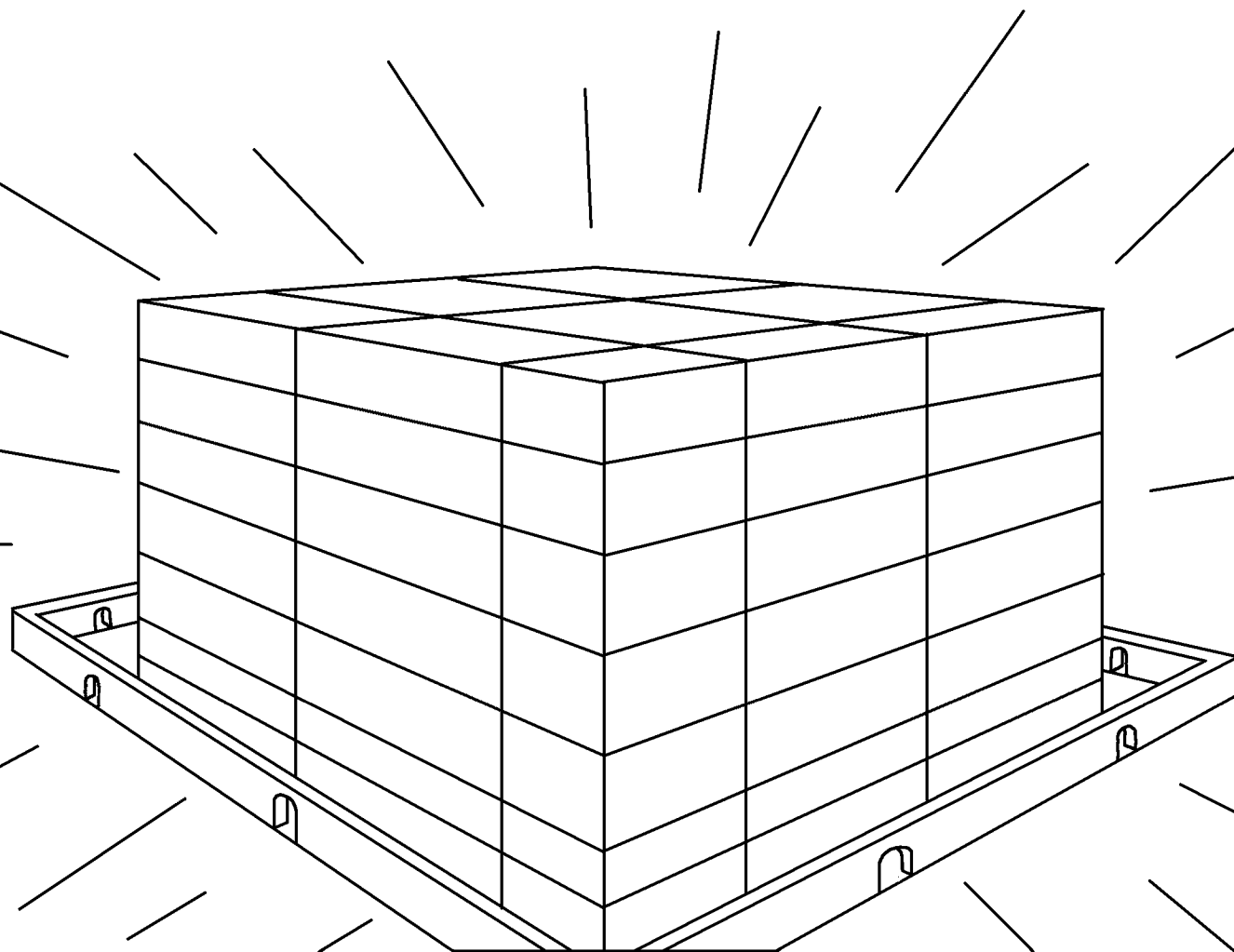

Olo-kolo' ri surugaé laing muto rupanna. Dé'gaga olo-kolo' maliya'. Asu ale' sibawa bémbala' manré wella massibawa. Namuni singaé manrétoi wella pada-pada sapingngé. Makkeda Puangngé, "Dé'gaga macilaka iyaréga mapeddi ri bulu' mapaccing-Ku."

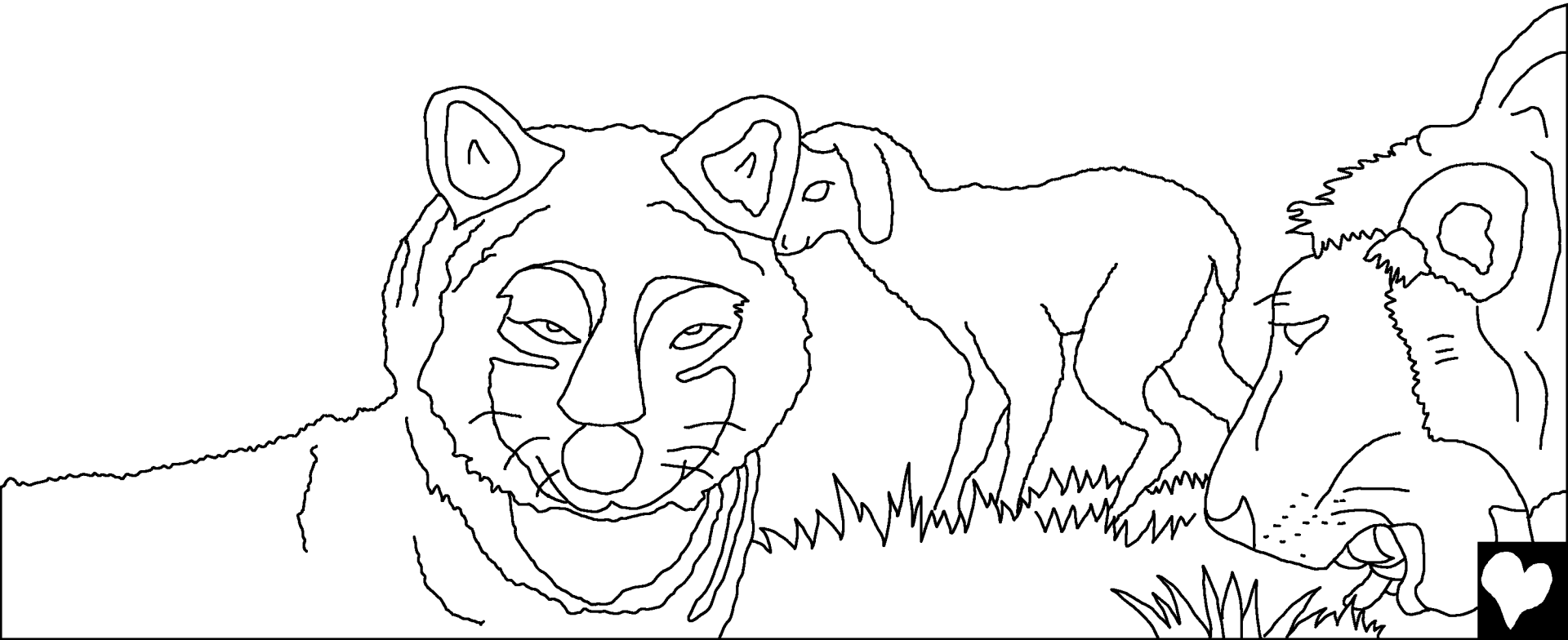

Narékkó makkitaki' risekelilitta, engka séddi de'gaga riruntu' ri Suruga. De'gaga ada-ada maja'riyangkalinga.

De'gaga tau mallaga atau simmusu'.

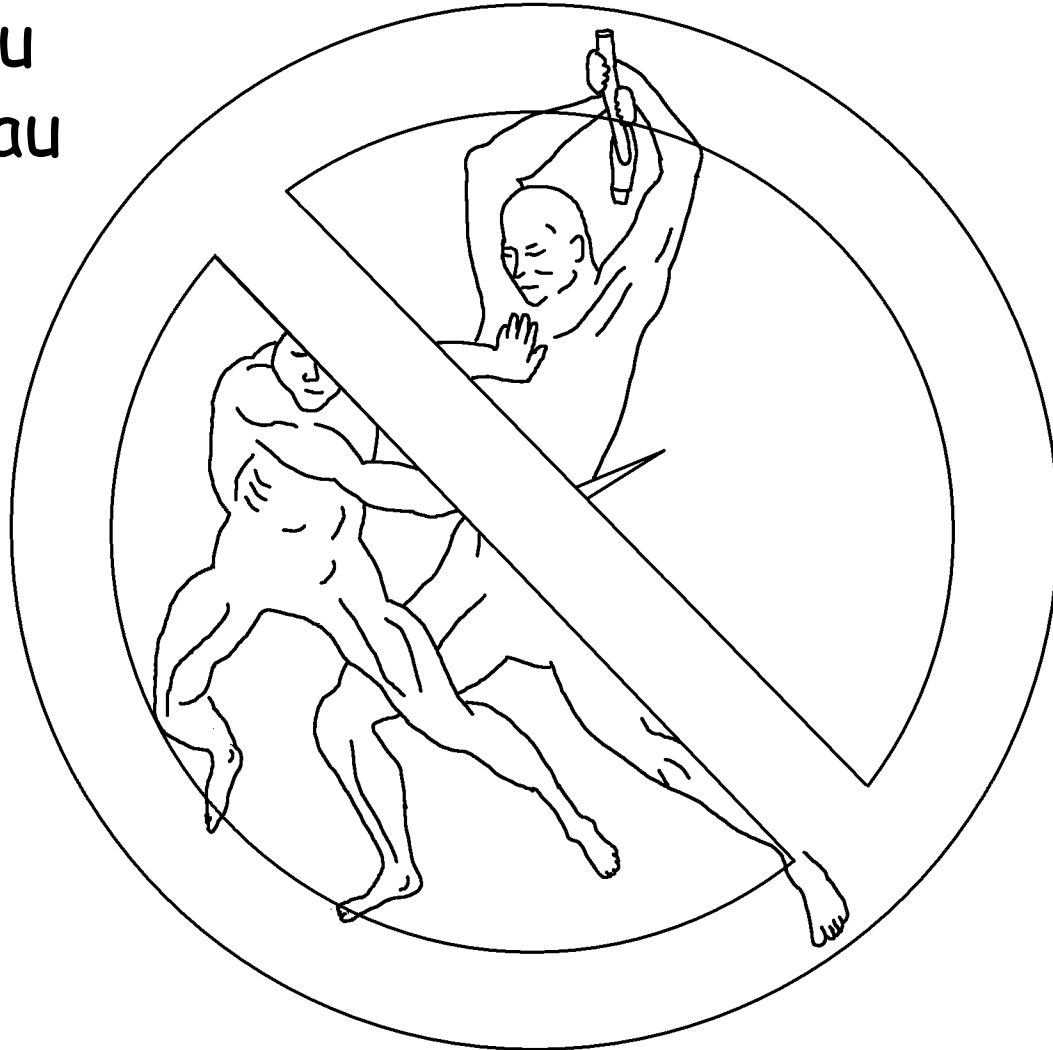

De'gaga goncing ri tange'é, nasaba' de'gaga panga ri
suruga. De'gaga pa'bellé-bellé, pauno, sanro sehéré,
iyaréga tau maja sipa'.

De'gaga dosa
turunan ri
suruga.



Dé'gaga uwai mata ri suruga.
Biasa tau mateppe'é kara'i
nasaba' anrasa-rasanna rilaleng
atuwonna. Ri suruga, Allataala
nasapu manengngi uwai mataé.



Dé'gaga amaténg risuruga. Tau mateppe'é engkai
tuwo mannennungeng ri suruga. De'gaga pessé na
anrasa-rasang, de'gaga terri, de'gaga
peddi. De'gaga lasa,
pesta, iyaréga
attampungeng.
Sininna engkaé
ri suruga
masennang
manengngi
sibawa
Allataala.



Iya madécéngngé, suruga untu' worowané sibawa
makkunrai iya mateppe'é lao ri Isa Almasih sélaku
pappasalama'na sibawa naturusiwi sélaku Puang.
Ri suruga engka séddi bo'bo' riyaseng Bo'
Atuwong. Engka maéga aseng rilalenna.
Muwissengngiga niga aseng riyoki'
rilalenna? Sininna tau
iya mateppe'é lao
ri Isa.

Engkaniga
asemmu kuwaro?

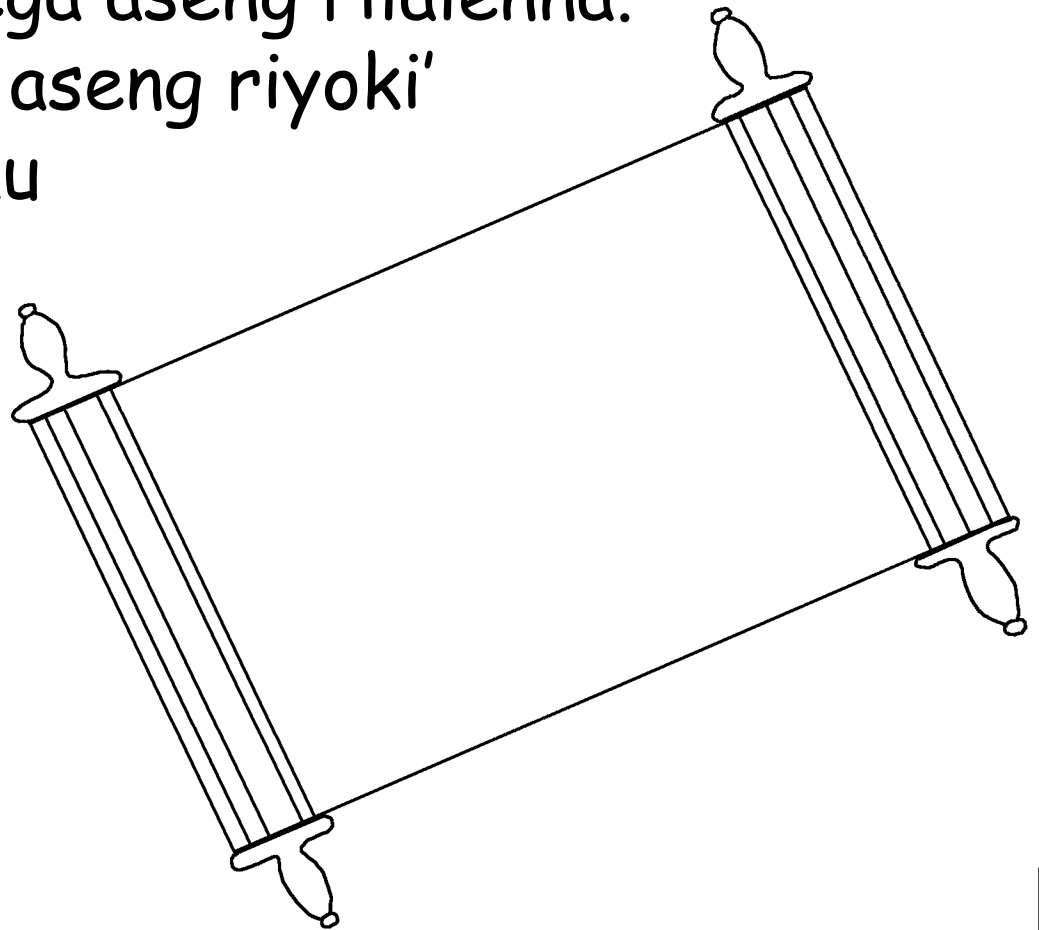

Ripaccappureнна kitta'é passalenna suruga engka
ada-ada iya kaminang makessingné lao mobbi'ki'.
"Makkedani Roh Mapaccingnge sibawa bottingné,
'Laoni maé!' Lappessani sininna maréngkalingaé
makkeda 'laoni Maé!'



Lappessani tau madekkaé maddeppé. Sininna tau
parellué, lappessani tarima uwai atuwong sicara
cuma-cuma."

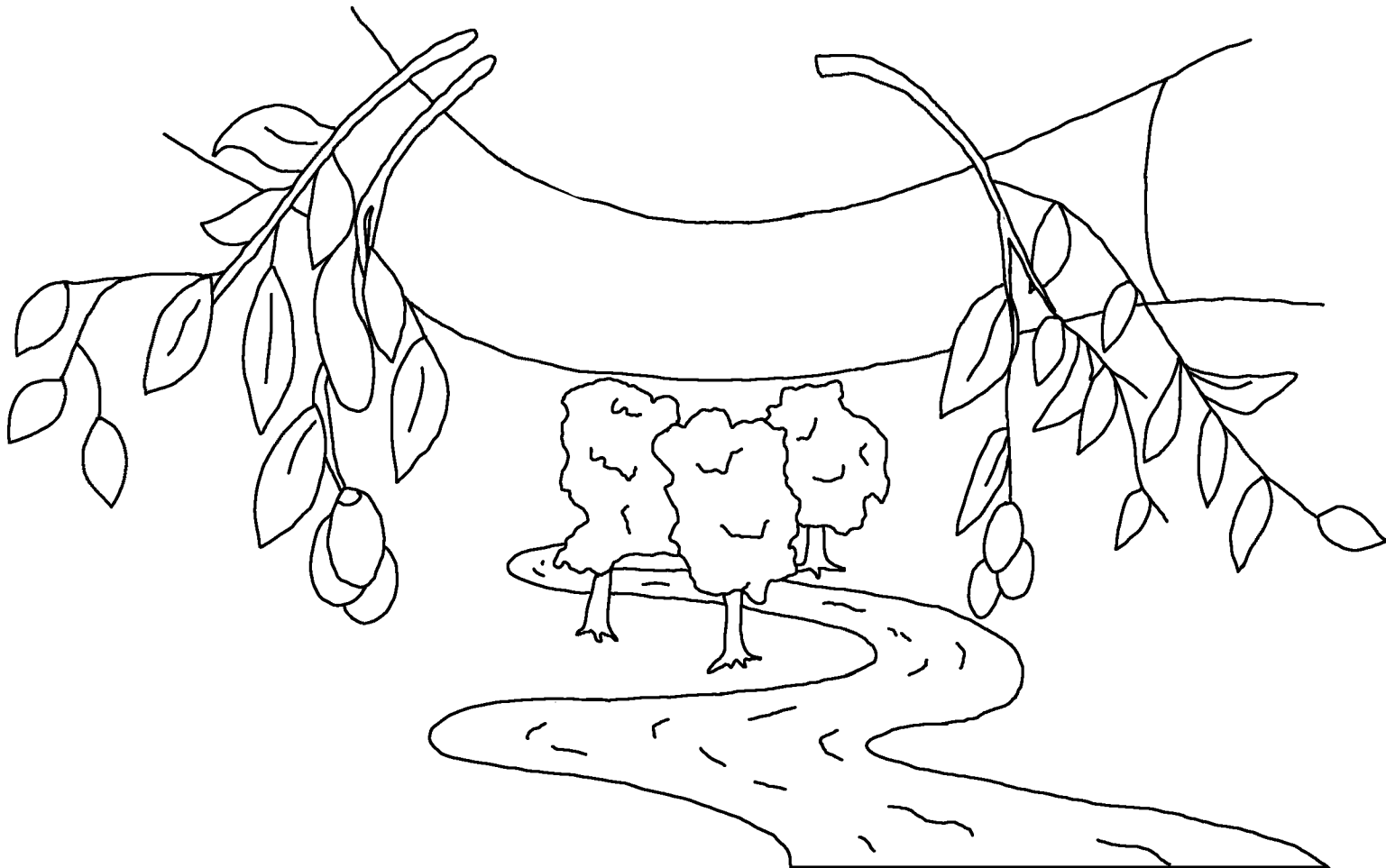

Suruga, Bolana Allataala iya makessingngé

Seddi curita polé riada-adanna Puang
Allataala, Al Kitab,

riruntu' rilaleng

Yohanes 14, 2 Korintus 5,
Wahyu 4, 21, 22

"Rekko ripakanessai, ma'bbérei tajang
pappaguruwam-Mu." Mazmur 119:130



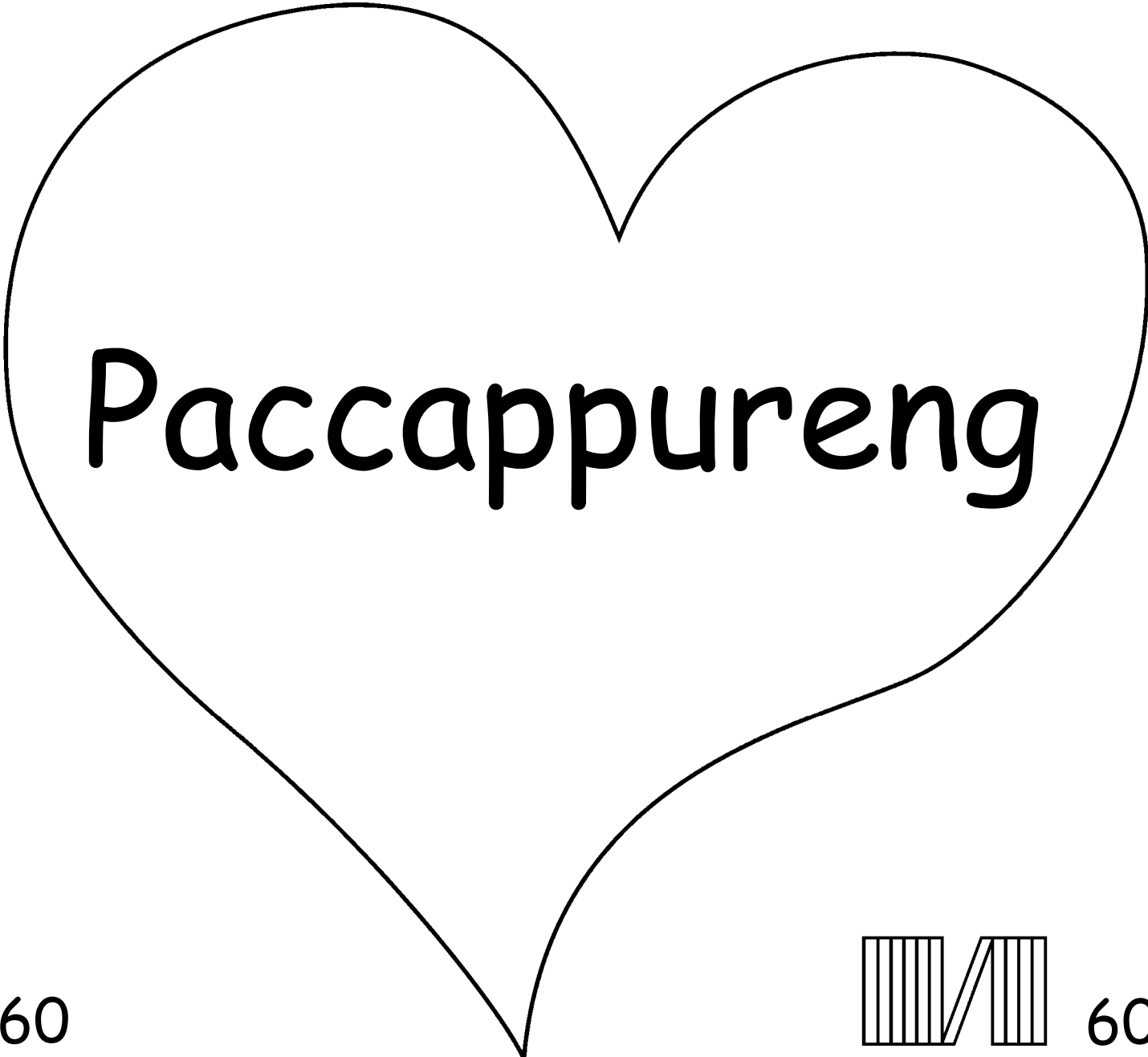

Paccappareng



60

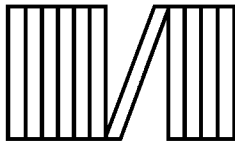

60



Iyaré curita pole ri Al-Kitab powadai passalenna Puang kaminang malebbi'é iya puraé pancajiki,' naiya maélo' toi kuammengngi idi' misseng toi Aléna.

Puangngé naissengngi makkeda purai ri pogau maja'é, iya riasengngé dosa. Pahukkungenna dosaé iyanaritu amateng, iyakiya Puangngé makkumani namaséi ki' na nabbéréangngi Ana' tungke'na, Isa, untu' maté ri aju salli'é sibawa tarimai pahukkungenna dosaé. Isa réwe'I ri atuwongngé sibawa lisui ri bola ri Suruga! Narékko mateppe'ki lao ri Isa na marellau ki' addampengeng lao ri dosata, maéloi pogau'I! MaéloI muttama sibawa monro ri laleng atuwommu, sibawa maéloI tuwo sibawaki' manennungeng.

Narékkko mateppe'ki' makkedaé tongengngi iya ada-adaé, powadai makkuwa lao ri Puangngé:

O Isa, mateppe'ka makkeda Idi' nату Puang, purani' mancaji tau lino enrengngé maté ri dosa-dosa ku, iyakiya makkekkuwangngé tuwoki' paimeng, Muttamaki' ri laleng atuwokku sibawa addampengengngi dosa-dosaku, kuwammengngi weddingngi ku tarimai atuwong mabarué, sibawa engka wettu kuwammengngi weddikka' sibawa ki' mannennungeng.

Tulungka' maccowé ri Idi' sibawa tuwo pada-pada ana'ta. Amin.

Bacai kitta'é sibawa abbicaraki' lao ri Puangngé esso-esso! Yohanes 3:16

